

Ezi-SERVO[®]

Closed Loop Stepping System

- Motor + Encoder + Drive + Controller + Network
- Embedded Controller
- Position Table
- Closed Loop Stepping System
- No Gain Tuning / No Hunting
- High Resolution / Fast Response
- IP65 Protection (NEMA24 Size)

ALL



CE

FASTECH

Fast, Accurate, Smooth Motion

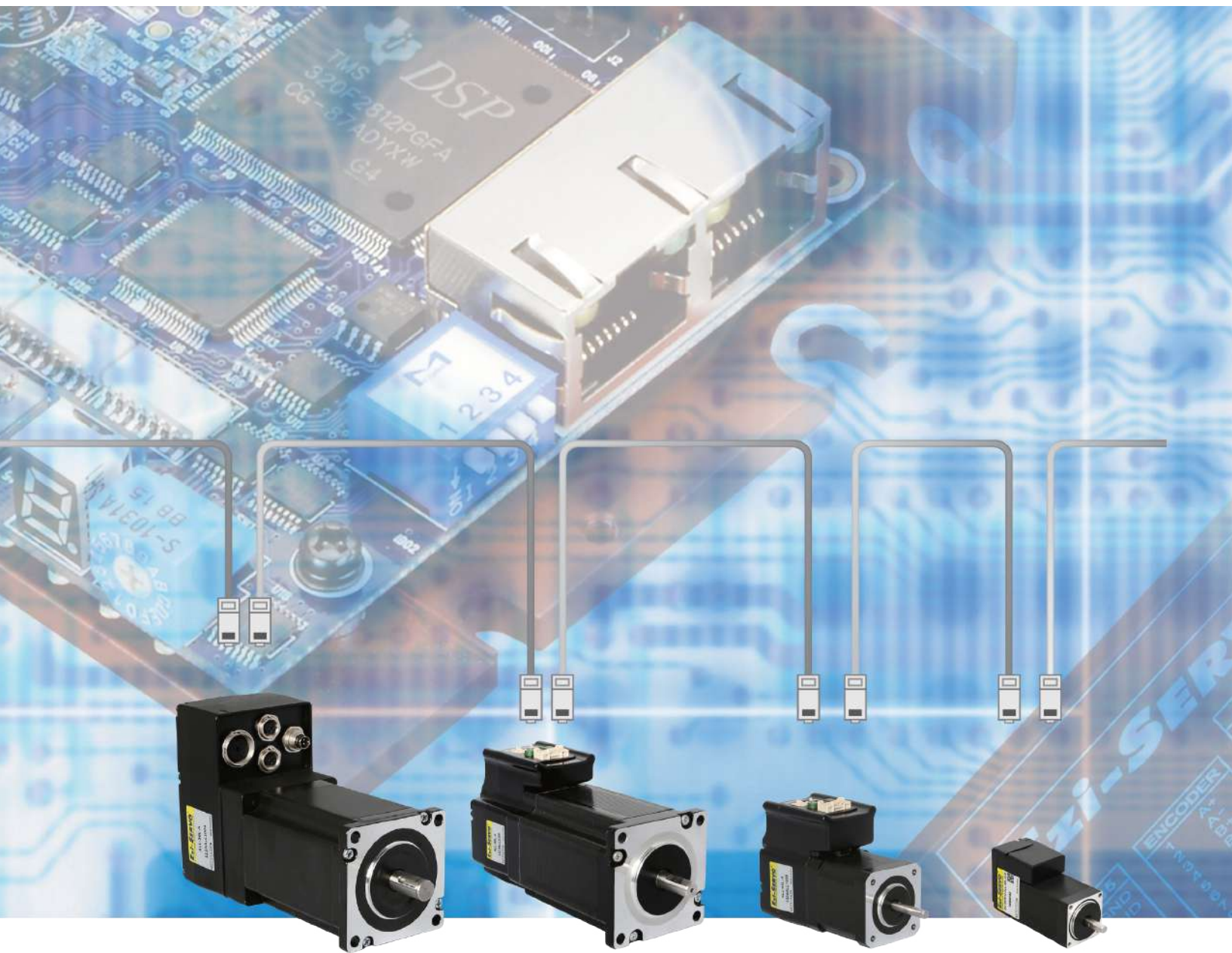

Fast, Accurate, Smooth Motion

Ezi-SERVO® **ALL**

Closed Loop Stepping System



1 Network Based Motion Control

A maximum of 16 axis can be operated from a PC through RS-485 communications. All of the Motion conditions are set through the network and saved in Flash ROM as a parameter.

Motion Library(DLL) is provided for programming under Windows XP/7/8/10.



2 Position Table Function

Position Table can be used for motion control by digital input and output signals of host controller.

You can operate the motor directly by sending the position table number, start/stop, origin search and other digital input values from a PLC.

The PLC can monitor the In-Position, origin search, moving/stop, Servo ready and other digital output signals from a drive. A maximum of 64 positioning points can be set from PLC.

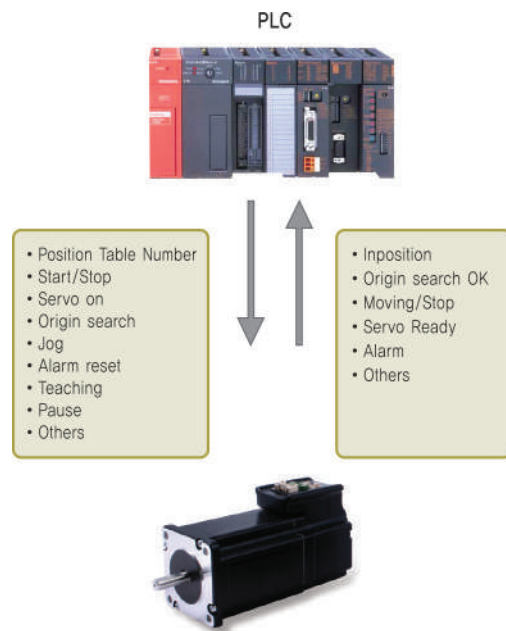

* 28mm product does not support function.

3 Closed Loop System

Ezi-SERVO is an innovative closed loop stepping system that utilizes a high-resolution motor mounted encoder constantly to monitor the current position. The encoder feedback allows the Ezi-SERVO to update the current position every 25 micro seconds. It allows the Ezi-SERVO drive to compensate for the loss of position, ensuring accurate positioning. For example, due to a sudden load change, a conventional stepper motor and drive could lose a step but Ezi-SERVO automatically correct the position by encoder feedback.

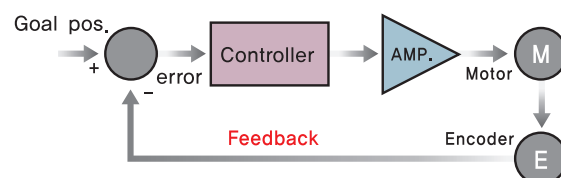

4 Absolute Encoder System

High resolution of absolute position encoder is equipped (single turn: 262,144/rev, multi turn: 4,096/rev) In addition, even power supply of driver shuts off, it enables to know the previous location and the secondary power supply for the encoder (ie : battery) is not required.

※ Only for Ezi-SERVO-ALL-60-ABS series



5 IP65 Protection

By acquiring IP65 rating, it can be used in harsh environments like water splashes or lots of dusts.

※ Only for Ezi-SERVO-ALL-60/60-ABS series

6 No Gain Tuning

To ensure machine performance, smoothness, positional error and low servo noise, conventional servo systems require the adjustment of its servo's gains as an initial crucial step. Even systems that employ auto-tuning require manual tuning after the system is installed, especially if more than one axis are interdependent. Ezi-SERVO employs the best characteristics of stepper, closed loop motion controls and algorithms to eliminate the need of tedious gain tuning required for conventional closed loop servo systems. This means that Ezi-SERVO is optimized for the application and ready to work right out of the box. The Ezi-SERVO system employs the unique characteristics of the closed loop stepping motor control, eliminating these cumbersome steps and giving the engineer a high performance servo system without wasting setup time. Ezi-SERVO is especially well suited for low stiffness loads (for example, a belt and pulley system) that sometime require conventional servo systems to inertia match with the additional expensive and bulky gearbox.

Ezi-SERVO also performs exceptionally, even under heavy loads and high speeds.

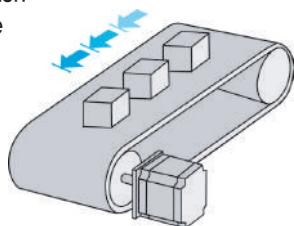

7 Heat Reduction / Energy Saving

(Motor Current Control according to load)

Ezi-SERVO automatically controls motor current according to load. Ezi-SERVO reduces motor current when motor load is low, and increases motor current when load is high. By optimizing the motor current, motor heat can be minimized and energy saved.

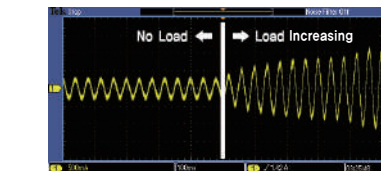
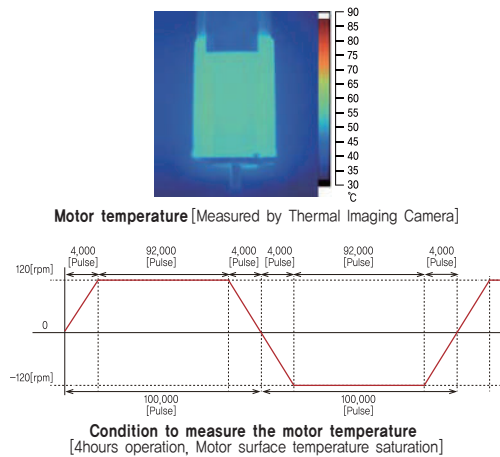

Example of the Motor Current Control according to load

8 Torque Improvement

(Motor Current Setting)

Ezi-SERVO can increase the motor current up to 150% by setting the Run Current by parameter. Therefore, acceleration and deceleration characteristics and torque characteristics at low speed can be increased.

Ezi-SERVO can improve the torque in the low speed range by about 30%.

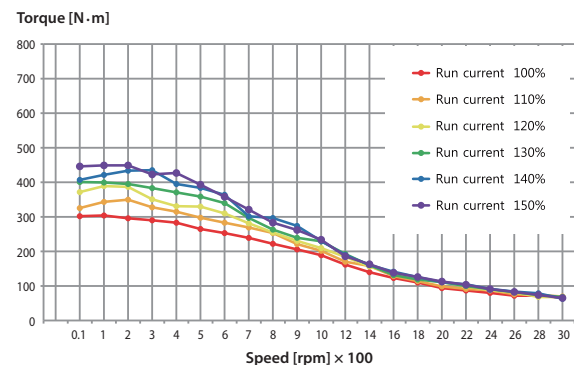

※ The torque at low speed is improved about 30%.

Measured Condition : Drive = Ezi-SERVO-ALL-42L
Motor Voltage = 24VDC
Input Voltage = 24VDC

9 No Hunting

Traditional servo motor drives overshoot their position and try to correct overshooting by moving the opposite direction, especially in high gain applications. This is called null hunt and is especially prevalent in systems that the break away or static friction is significantly higher than the running friction. The cure is lowering the gain, which affects accuracy or using Ezi-SERVO Motion Control System. Ezi-SERVO utilizes the unique characteristics of stepping motors and locks itself into the desired target position, eliminating Null Hunt. This feature is especially useful in applications such as nanotech manufacturing, semiconductor fabrication, vision systems and ink jet printing in which system oscillation and vibration could be a problem.

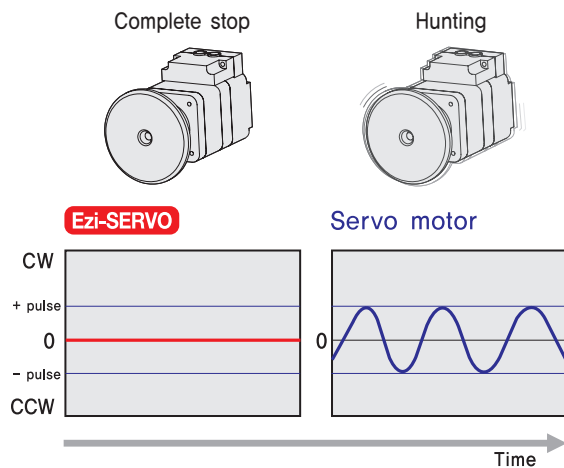

10 Smooth and Accurate

Ezi-SERVO is a high-precision servo drive, using a high-resolution encoder with 20,000 pulses/revolution. Unlike a conventional Microstep drive, the on-board high performance DSP (Digital Signal Processor) performs vector control and filtering, producing a smooth rotational control with minimum ripples.

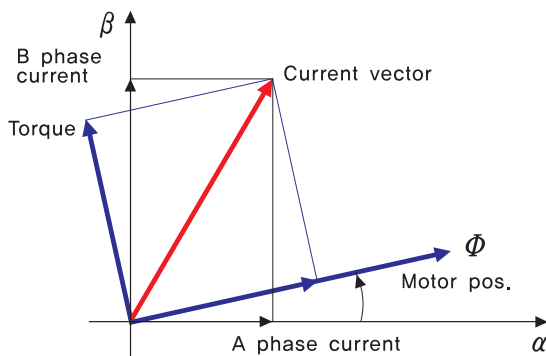

11 Fast Response

Similar to conventional stepping motors, Ezi-SERVO instantly synchronizes with command pulses providing fast positional response. Ezi-SERVO is the optimum choice when zero-speed stability and rapid motions within a short distance are required. Traditional servo motor systems have a natural delay called settling time between the command input signals and the resultant motion because of the constant monitoring of the current position.

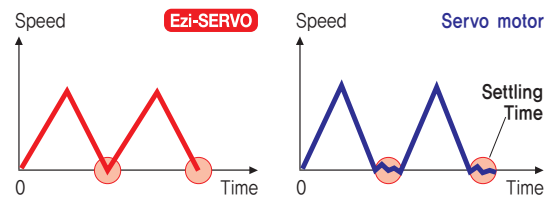

12 High Resolution

The unit of the position command can be divided precisely. (Max. 20,000 pulses/revolution)

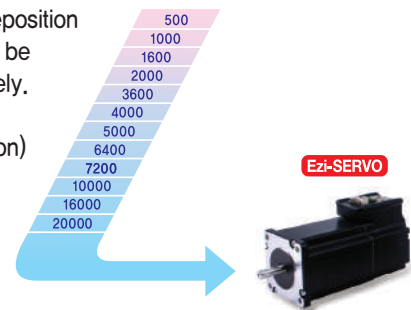

13 High Torque

Compared with common step motors and drives, Ezi-SERVO motion control systems can maintain a high torque state over relatively long period of time. This means that Ezi-SERVO continuously operates without loss of position under 100% of the load. Unlike conventional Microstep drives, Ezi-SERVO exploits continuous high torque operation during high speed motion due to its innovative optimum current phase control.

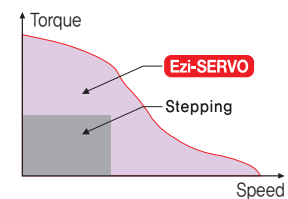

14 High Speed

The Ezi-SERVO operates well at high speed without the loss of synchronism or positioning error. Ezi-SERVO's ability of continuous current position monitoring of enables the stepping motor to generate high torque, even under a 100% load condition.

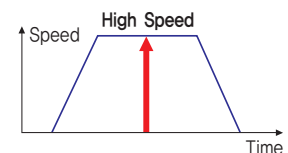

● Advantages over Open–Loop Control Stepping Drive

1. Reliable positioning without loss of synchronism.
2. Holding stable position and automatically recovering to the original position even after experiencing positioning error due to external forces, such as mechanical vibration or vertical positional holding.
3. Ezi–SERVO utilizes 100% of the full range of rated motor torque, contrary to a conventional open–loop stepping driver that can use up to 50% of the rated motor torque due to the loss of synchronism.
4. Capability to operate at high speed due to load–dependant current control, open–loop stepping drivers use a constant current control at all speed ranges without considering load variations.

● Advantages over Servo Motor Controller

1. No gain tuning. (Automatic gain adjustment in response to a load change)
2. Maintains the stable holding position without oscillation after completion of positioning.
3. Fast positioning due to the independent control by on–board DSP.
4. Continuous operation during rapid short–stroke movement due to instantaneous positioning.

● Features of Motion Controller

1. Loop Count

This function allows positioning repeatedly according to the Loop Count Number.

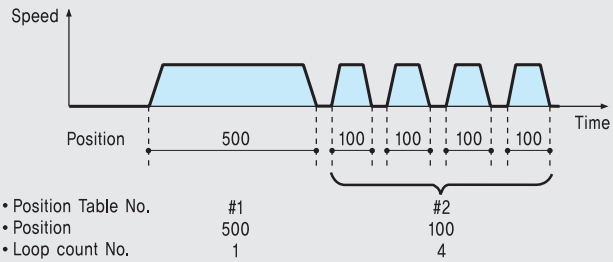

2. Acceleration/Deceleration

For quick acceleration and gradual deceleration, you can set each acceleration and deceleration time separately.

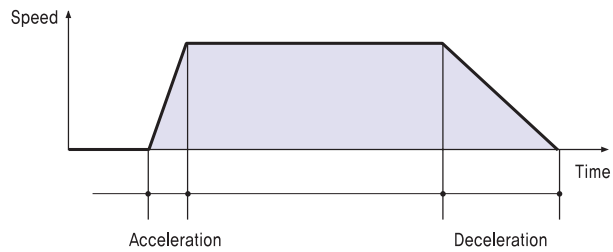

3. Pause

You can pause the motion upon the input of an external signal. When Pause signal change to OFF, the motor will restart to original target position.

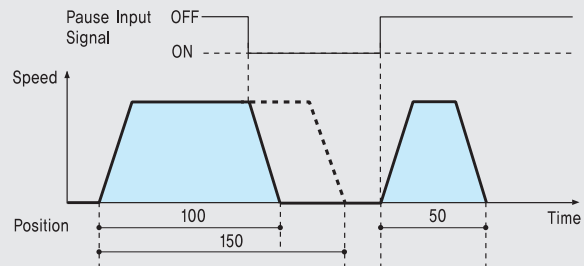

4. Alarm

The number of 7-segment flashing time indicates which Alarm has occurred.

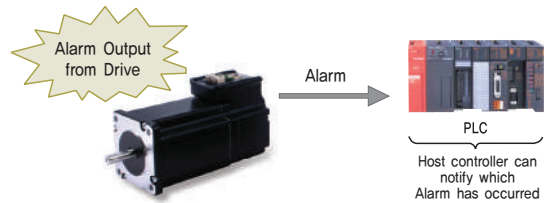

5. Teaching

Teaching signal is used to memorize current Position data into the selected Position Table item.

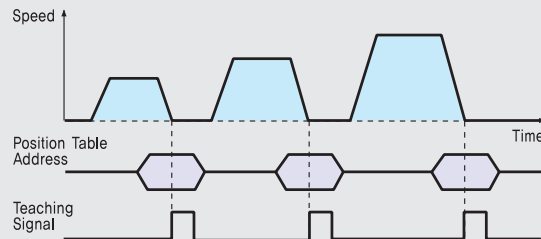

6. Jump

Within one Position Table, you can select various Position Table numbers that you want to jump. With three external input signal during movement, the next jump Position Table number can be select.

◆ Position Table #14

Position	---	Next	---	Input 1	Input 2	Input 3	---
10000		32		60	61	62	

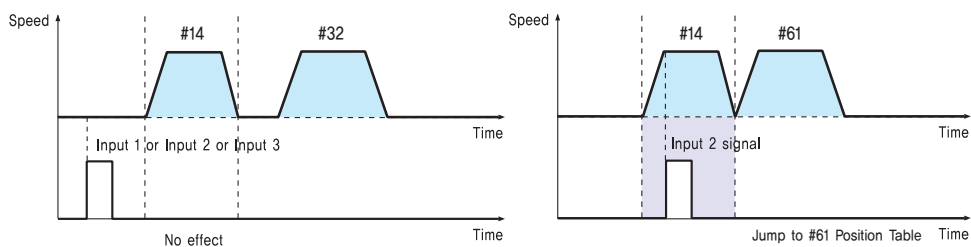

● Ezi-SERVO ALL Part Numbering

Ezi-SERVO-ALL-42S-A-BK-PN05-□

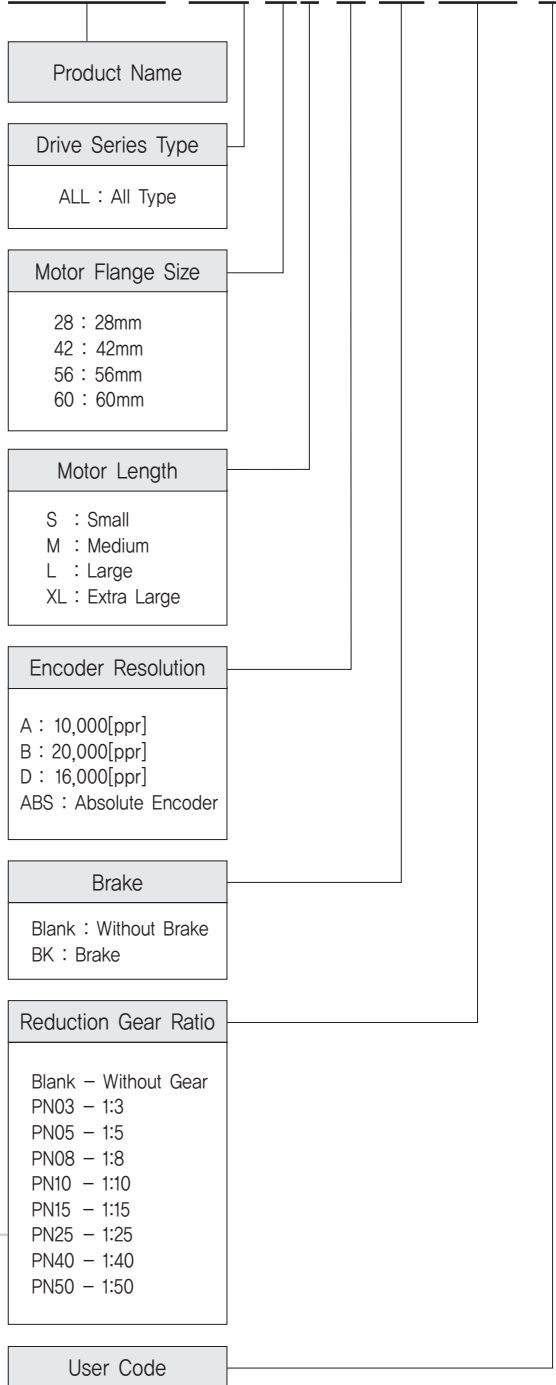

FASTECH Ezi-SERVO ALL

● Standard Combination

Unit Part Number	Motor Model Number	Drive Model Number
Ezi-SERVO-ALL-28S-D	Motor & Drive Integrated	
Ezi-SERVO-ALL-28M-D		
Ezi-SERVO-ALL-28L-D		
Ezi-SERVO-ALL-42S-A		
Ezi-SERVO-ALL-42S-B		
Ezi-SERVO-ALL-42M-A		
Ezi-SERVO-ALL-42M-B		
Ezi-SERVO-ALL-42L-A		
Ezi-SERVO-ALL-42L-B		
Ezi-SERVO-ALL-42XL-A		
Ezi-SERVO-ALL-42XL-B		
Ezi-SERVO-ALL-56S-A		
Ezi-SERVO-ALL-56S-B		
Ezi-SERVO-ALL-56M-A		
Ezi-SERVO-ALL-56M-B		
Ezi-SERVO-ALL-56L-A		
Ezi-SERVO-ALL-56L-B		
Ezi-SERVO-ALL-60S-A		
Ezi-SERVO-ALL-60S-B		
Ezi-SERVO-ALL-60S-ABS		
Ezi-SERVO-ALL-60M-A		
Ezi-SERVO-ALL-60M-B		
Ezi-SERVO-ALL-60M-ABS		
Ezi-SERVO-ALL-60L-A		
Ezi-SERVO-ALL-60L-B		
Ezi-SERVO-ALL-60L-ABS		

● Combination with Brake

Unit Part Number	Motor Model Number	Drive Model Number
Ezi-SERVO-ALL-42S-A-BK	Motor & Drive Integrated	
Ezi-SERVO-ALL-42S-B-BK		
Ezi-SERVO-ALL-42M-A-BK		
Ezi-SERVO-ALL-42M-B-BK		
Ezi-SERVO-ALL-42L-A-BK		
Ezi-SERVO-ALL-42L-B-BK		
Ezi-SERVO-ALL-42XL-A-BK		
Ezi-SERVO-ALL-42XL-B-BK		
Ezi-SERVO-ALL-56S-A-BK		
Ezi-SERVO-ALL-56S-B-BK		
Ezi-SERVO-ALL-56M-A-BK		
Ezi-SERVO-ALL-56M-B-BK		
Ezi-SERVO-ALL-56L-A-BK		
Ezi-SERVO-ALL-56L-B-BK		
Ezi-SERVO-ALL-60S-A-BK		
Ezi-SERVO-ALL-60S-B-BK		
Ezi-SERVO-ALL-60M-A-BK		
Ezi-SERVO-ALL-60M-B-BK		
Ezi-SERVO-ALL-60L-A-BK		
Ezi-SERVO-ALL-60L-B-BK		

● Combination with Gearbox

Unit Part Number	Motor Model Number	Drive Model Number	Reduction gear ratio
Ezi-SERVO-ALL-42S-A-PN3	Motor & Drive Integrated		1:3
Ezi-SERVO-ALL-42S-B-PN3			1:5
Ezi-SERVO-ALL-42S-A-PN5			1:8
Ezi-SERVO-ALL-42S-B-PN5			
Ezi-SERVO-ALL-42S-A-PN8			1:10
Ezi-SERVO-ALL-42S-B-PN8			
Ezi-SERVO-ALL-42S-A-PN10			1:15
Ezi-SERVO-ALL-42S-B-PN10			
Ezi-SERVO-ALL-42S-A-PN15			1:25
Ezi-SERVO-ALL-42S-B-PN15			
Ezi-SERVO-ALL-42S-A-PN25			1:40
Ezi-SERVO-ALL-42S-B-PN25			
Ezi-SERVO-ALL-42S-A-PN40			1:50
Ezi-SERVO-ALL-42S-B-PN40			
Ezi-SERVO-ALL-42S-A-PN50			1:3
Ezi-SERVO-ALL-42S-B-PN50			
Ezi-SERVO-ALL-42M-A-PN3			1:5
Ezi-SERVO-ALL-42M-B-PN3			
Ezi-SERVO-ALL-42M-A-PN5			1:8
Ezi-SERVO-ALL-42M-B-PN5			
Ezi-SERVO-ALL-42M-A-PN8			1:10
Ezi-SERVO-ALL-42M-B-PN8			
Ezi-SERVO-ALL-42M-A-PN10			1:15
Ezi-SERVO-ALL-42M-B-PN10			
Ezi-SERVO-ALL-42M-A-PN15			1:25
Ezi-SERVO-ALL-42M-B-PN15			
Ezi-SERVO-ALL-42M-A-PN25			1:40
Ezi-SERVO-ALL-42M-B-PN25			
Ezi-SERVO-ALL-42M-A-PN40			1:50
Ezi-SERVO-ALL-42M-B-PN40			
Ezi-SERVO-ALL-42M-A-PN50			
Ezi-SERVO-ALL-42M-B-PN50			

● Combination with Gearbox

Unit Part Number	Motor Model Number	Drive Model Number	Reduction gear ratio
Ezi-SERVO-ALL-42L-A-PN3	Motor & Drive Integrated		1:3
Ezi-SERVO-ALL-42L-B-PN3			1:5
Ezi-SERVO-ALL-42L-A-PN5			
Ezi-SERVO-ALL-42L-B-PN5			1:8
Ezi-SERVO-ALL-42L-A-PN8			
Ezi-SERVO-ALL-42L-B-PN8			1:10
Ezi-SERVO-ALL-42L-A-PN10			
Ezi-SERVO-ALL-42L-B-PN10			1:15
Ezi-SERVO-ALL-42L-A-PN15			
Ezi-SERVO-ALL-42L-B-PN15			1:25
Ezi-SERVO-ALL-42L-A-PN25			
Ezi-SERVO-ALL-42L-B-PN25			1:40
Ezi-SERVO-ALL-42L-A-PN40			
Ezi-SERVO-ALL-42L-B-PN40			1:50
Ezi-SERVO-ALL-42L-A-PN50			
Ezi-SERVO-ALL-42L-B-PN50			1:3
Ezi-SERVO-ALL-42XL-A-PN3			
Ezi-SERVO-ALL-42XL-B-PN3			1:5
Ezi-SERVO-ALL-42XL-A-PN5			
Ezi-SERVO-ALL-42XL-B-PN5			1:8
Ezi-SERVO-ALL-42XL-A-PN8			
Ezi-SERVO-ALL-42XL-B-PN8			1:10
Ezi-SERVO-ALL-42XL-A-PN10			
Ezi-SERVO-ALL-42XL-B-PN10			1:15
Ezi-SERVO-ALL-42XL-A-PN15			
Ezi-SERVO-ALL-42XL-B-PN15			1:25
Ezi-SERVO-ALL-42XL-A-PN25			
Ezi-SERVO-ALL-42XL-B-PN25			1:40
Ezi-SERVO-ALL-42XL-A-PN40			
Ezi-SERVO-ALL-42XL-B-PN40			1:50
Ezi-SERVO-ALL-42XL-A-PN50			
Ezi-SERVO-ALL-42XL-B-PN50			1:3
Ezi-SERVO-ALL-56S-A-PN3			
Ezi-SERVO-ALL-56S-B-PN3			1:5
Ezi-SERVO-ALL-56S-A-PN5			
Ezi-SERVO-ALL-56S-B-PN5			1:8
Ezi-SERVO-ALL-56S-A-PN8			
Ezi-SERVO-ALL-56S-B-PN8			1:10
Ezi-SERVO-ALL-56S-A-PN10			
Ezi-SERVO-ALL-56S-B-PN10			1:15
Ezi-SERVO-ALL-56S-A-PN15			
Ezi-SERVO-ALL-56S-B-PN15			1:25
Ezi-SERVO-ALL-56S-A-PN25			
Ezi-SERVO-ALL-56S-B-PN25			1:40
Ezi-SERVO-ALL-56S-A-PN40			
Ezi-SERVO-ALL-56S-B-PN40			1:50
Ezi-SERVO-ALL-56S-A-PN50			
Ezi-SERVO-ALL-56S-B-PN50			1:3
Ezi-SERVO-ALL-56M-A-PN3			
Ezi-SERVO-ALL-56M-B-PN3			1:5
Ezi-SERVO-ALL-56M-A-PN5			
Ezi-SERVO-ALL-56M-B-PN5	1:8		
Ezi-SERVO-ALL-56M-A-PN8			
Ezi-SERVO-ALL-56M-B-PN8	1:10		
Ezi-SERVO-ALL-56M-A-PN10			
Ezi-SERVO-ALL-56M-B-PN10	1:15		
Ezi-SERVO-ALL-56M-A-PN15			
Ezi-SERVO-ALL-56M-B-PN15	1:25		
Ezi-SERVO-ALL-56M-A-PN25			
Ezi-SERVO-ALL-56M-B-PN25	1:40		
Ezi-SERVO-ALL-56M-A-PN40			
Ezi-SERVO-ALL-56M-B-PN40	1:50		
Ezi-SERVO-ALL-56M-A-PN50			
Ezi-SERVO-ALL-56M-B-PN50			

● Combination with Gearbox

Unit Part Number	Motor Model Number	Drive Model Number	Reduction gear ratio
Ezi-SERVO-ALL-56L-A-PN3	Motor & Drive Integrated		1:3
Ezi-SERVO-ALL-56L-B-PN3			1:5
Ezi-SERVO-ALL-56L-A-PN5			1:8
Ezi-SERVO-ALL-56L-B-PN5			1:10
Ezi-SERVO-ALL-56L-A-PN8			1:15
Ezi-SERVO-ALL-56L-B-PN8			1:25
Ezi-SERVO-ALL-56L-A-PN10			1:40
Ezi-SERVO-ALL-56L-B-PN10			1:50
Ezi-SERVO-ALL-56L-A-PN15			1:3
Ezi-SERVO-ALL-56L-B-PN15			1:5
Ezi-SERVO-ALL-56L-A-PN25			1:8
Ezi-SERVO-ALL-56L-B-PN25			1:10
Ezi-SERVO-ALL-56L-A-PN40			1:15
Ezi-SERVO-ALL-56L-B-PN40			1:25
Ezi-SERVO-ALL-56L-A-PN50			1:3
Ezi-SERVO-ALL-56L-B-PN50			1:5
Ezi-SERVO-ALL-60S-A-PN3			1:8
Ezi-SERVO-ALL-60S-B-PN3			1:10
Ezi-SERVO-ALL-60S-ABS-PN3			1:15
Ezi-SERVO-ALL-60S-A-PN5			1:25
Ezi-SERVO-ALL-60S-B-PN5			1:40
Ezi-SERVO-ALL-60S-ABS-PN5			1:50
Ezi-SERVO-ALL-60S-A-PN8			1:3
Ezi-SERVO-ALL-60S-B-PN8			1:5
Ezi-SERVO-ALL-60S-ABS-PN8			1:8
Ezi-SERVO-ALL-60S-A-PN10			1:10
Ezi-SERVO-ALL-60S-B-PN10			1:15
Ezi-SERVO-ALL-60S-ABS-PN10			1:25
Ezi-SERVO-ALL-60S-A-PN15			1:40
Ezi-SERVO-ALL-60S-B-PN15			1:50
Ezi-SERVO-ALL-60S-ABS-PN15	1:3		
Ezi-SERVO-ALL-60S-A-PN25	1:5		
Ezi-SERVO-ALL-60S-B-PN25	1:8		
Ezi-SERVO-ALL-60S-ABS-PN25	1:10		
Ezi-SERVO-ALL-60S-A-PN40	1:15		
Ezi-SERVO-ALL-60S-B-PN40	1:25		
Ezi-SERVO-ALL-60S-ABS-PN40	1:40		
Ezi-SERVO-ALL-60S-A-PN50	1:50		
Ezi-SERVO-ALL-60S-B-PN50	1:3		
Ezi-SERVO-ALL-60S-ABS-PN50	1:5		

Unit Part Number	Motor Model Number	Drive Model Number	Reduction gear ratio
Ezi-SERVO-ALL-60M-A-PN3	Motor & Drive Integrated		1:3
Ezi-SERVO-ALL-60M-B-PN3			1:5
Ezi-SERVO-ALL-60M-ABS-PN3			1:8
Ezi-SERVO-ALL-60M-A-PN5			1:10
Ezi-SERVO-ALL-60M-B-PN5			1:15
Ezi-SERVO-ALL-60M-ABS-PN5			1:25
Ezi-SERVO-ALL-60M-A-PN8			1:40
Ezi-SERVO-ALL-60M-B-PN8			1:50
Ezi-SERVO-ALL-60M-ABS-PN8			1:3
Ezi-SERVO-ALL-60M-A-PN10			1:5
Ezi-SERVO-ALL-60M-B-PN10			1:8
Ezi-SERVO-ALL-60M-ABS-PN10			1:10
Ezi-SERVO-ALL-60M-A-PN15			1:15
Ezi-SERVO-ALL-60M-B-PN15			1:25
Ezi-SERVO-ALL-60M-ABS-PN15			1:40
Ezi-SERVO-ALL-60M-A-PN25			1:50
Ezi-SERVO-ALL-60M-B-PN25			1:3
Ezi-SERVO-ALL-60M-ABS-PN25			1:5
Ezi-SERVO-ALL-60M-A-PN40			1:8
Ezi-SERVO-ALL-60M-B-PN40			1:10
Ezi-SERVO-ALL-60M-ABS-PN40			1:15
Ezi-SERVO-ALL-60M-A-PN50			1:25
Ezi-SERVO-ALL-60M-B-PN50			1:40
Ezi-SERVO-ALL-60M-ABS-PN50			1:50
Ezi-SERVO-ALL-60L-A-PN3			1:3
Ezi-SERVO-ALL-60L-B-PN3			1:5
Ezi-SERVO-ALL-60L-ABS-PN3			1:8
Ezi-SERVO-ALL-60L-A-PN5			1:10
Ezi-SERVO-ALL-60L-B-PN5			1:15
Ezi-SERVO-ALL-60L-ABS-PN5			1:25
Ezi-SERVO-ALL-60L-A-PN8	1:40		
Ezi-SERVO-ALL-60L-B-PN8	1:50		
Ezi-SERVO-ALL-60L-ABS-PN8	1:3		
Ezi-SERVO-ALL-60L-A-PN10	1:5		
Ezi-SERVO-ALL-60L-B-PN10	1:8		
Ezi-SERVO-ALL-60L-ABS-PN10	1:10		
Ezi-SERVO-ALL-60L-A-PN15	1:15		
Ezi-SERVO-ALL-60L-B-PN15	1:25		
Ezi-SERVO-ALL-60L-ABS-PN15	1:40		
Ezi-SERVO-ALL-60L-A-PN25	1:50		
Ezi-SERVO-ALL-60L-B-PN25	1:3		
Ezi-SERVO-ALL-60L-ABS-PN25	1:5		
Ezi-SERVO-ALL-60L-A-PN40	1:8		
Ezi-SERVO-ALL-60L-B-PN40	1:10		
Ezi-SERVO-ALL-60L-ABS-PN40	1:15		
Ezi-SERVO-ALL-60L-A-PN50	1:25		
Ezi-SERVO-ALL-60L-B-PN50	1:40		
Ezi-SERVO-ALL-60L-ABS-PN50	1:50		

● Specifications of Motor

MODEL	UNIT	Ezi-SERVO-ALL-28 series			Ezi-SERVO-ALL-42 series			
		28S	28M	28L	42S	42M	42L	42XL
DRIVE METHOD	–	BI-POLAR						
NUMBER OF PHASES	–	2	2	2	2	2	2	2
VOLTAGE	VDC	3,0	3,0	3,0	3,36	4,32	4,56	7,2
CURRENT per PHASE	A	0,95	0,95	0,95	1,2	1,2	1,2	1,2
RESISTANCE per PHASE	Ohm	3,2	3,2	3,2	2,8	3,6	3,8	6,0
INDUCTANCE per PHASE	mH	2,0	2,7	3,2	5,4	7,2	8,0	15,6
HOLDING TORQUE	N·m	0,069	0,098	0,118	0,32	0,44	0,5	0,65
ROTOR INERTIA	g·cm ²	9,0	13	18	35	54	77	114
WEIGHTS	g	110	140	200	250	280	350	500
LENGTH(L)	mm	32	45	50	34	40	48	60
PERMISSIBLE OVERHUNG LOAD (DISTANCE FROM END OF SHAFT)	3mm	N	30	30	30	22	22	22
	8mm		38	38	38	26	26	26
	13mm		53	53	53	33	33	33
	18mm		–	–	–	46	46	46
PERMISSIBLE THRUST LOAD	N	Lower than motor weight						
INSULATION RESISTANCE	Mohm	100 MIN.(at 500VDC)						
INSULATION CLASS	–	CLASS B(130°C)						
OPERATING TEMPERATURE	°C	0 to 55						

MODEL	UNIT	Ezi-SERVO-ALL-56 series			Ezi-SERVO-ALL-60 series			
		56S	56M	56L	60S	60M	60L	
DRIVE METHOD	–	BI-POLAR						
NUMBER OF PHASES	–	2	2	2	2	2	2	
VOLTAGE	VDC	1,56	1,62	2,64	1,32	1,48	2,2	
CURRENT per PHASE	A	3,0	3,0	3,0	4,0	4,0	4,0	
RESISTANCE per PHASE	Ohm	0,52	0,54	0,88	0,33	0,37	0,55	
INDUCTANCE per PHASE	mH	1,2	2,0	4,0	0,75	1,1	2,7	
HOLDING TORQUE	N·m	0,64	1,0	1,5	0,88	1,28	2,4	
ROTOR INERTIA	g·cm ²	180	280	520	240	490	690	
WEIGHTS	g	500	720	1150	600	1000	1300	
LENGTH(L)	mm	46	55	80	47	56	85	
PERMISSIBLE OVERHUNG LOAD (DISTANCE FROM END OF SHAFT)	3mm	N	52	52	52	70	70	70
	8mm		65	65	65	87	87	87
	13mm		85	85	85	114	114	114
	18mm		123	123	123	165	165	165
PERMISSIBLE THRUST LOAD	N	Lower than motor weight						
INSULATION RESISTANCE	Mohm	100 MIN.(at 500VDC)						
INSULATION CLASS	–	CLASS B(130°C)						
OPERATING TEMPERATURE	°C	0 to 55						

Torque Characteristics of Motor

Ezi-SERVO-ALL-28 series

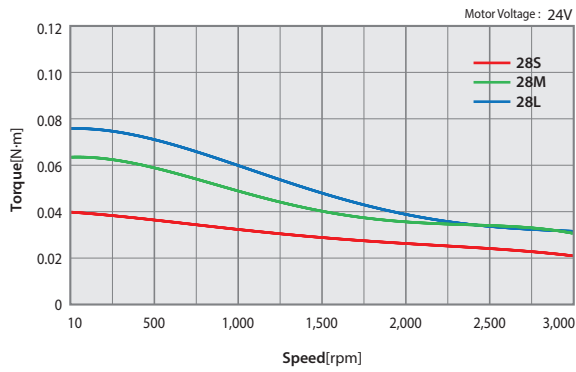

Ezi-SERVO-ALL-42 series

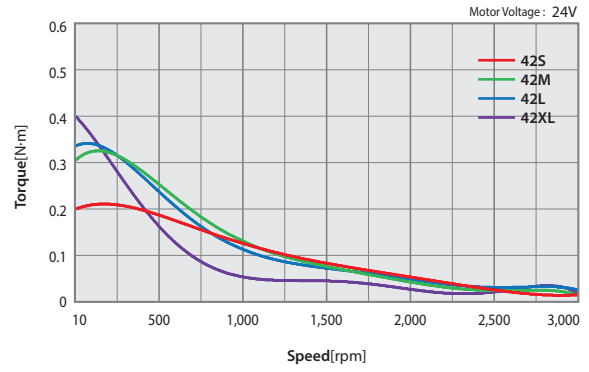

Ezi-SERVO-ALL-56 series

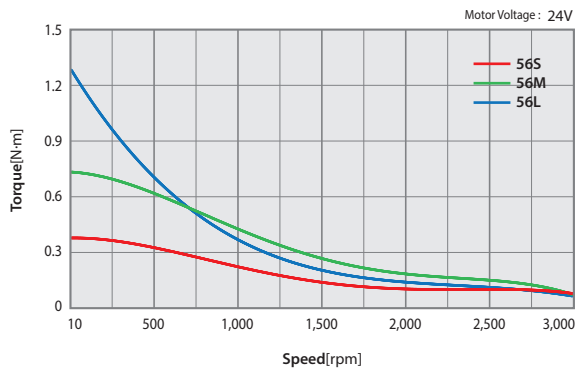

Ezi-SERVO-ALL-60 series

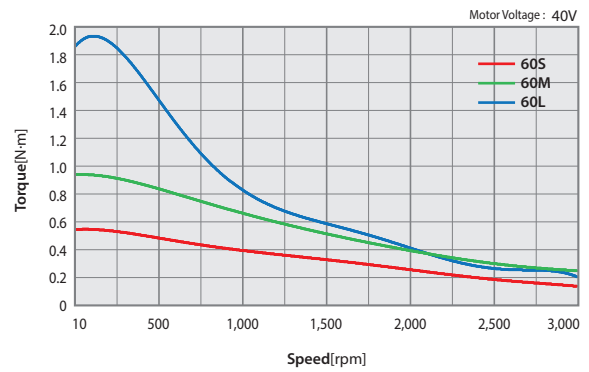

● Dimensions of Motor [mm]

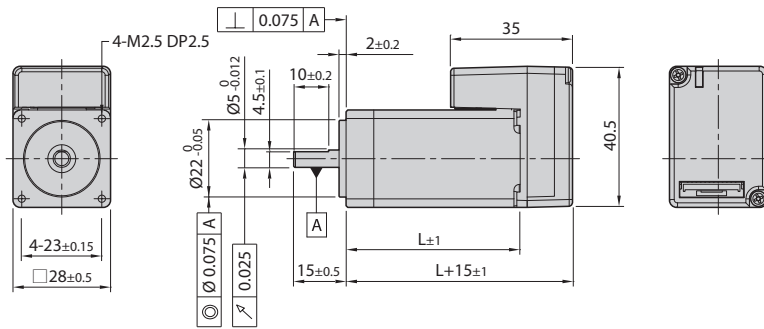

28mm

Model name	Length(L)
28S	32
28M	45
28L	50

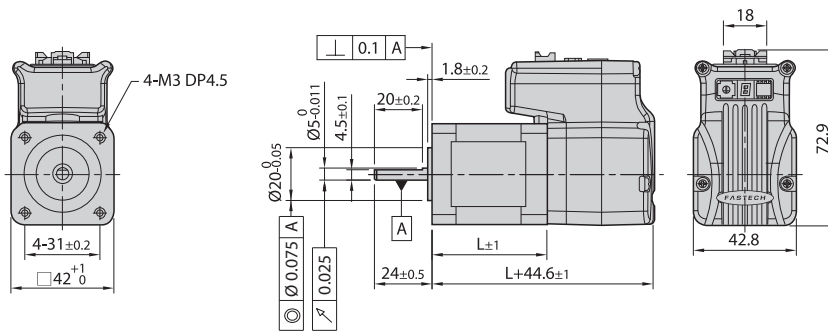

42mm

Model name	Length(L)
42S	34
42M	40
42L	48
42XL	60

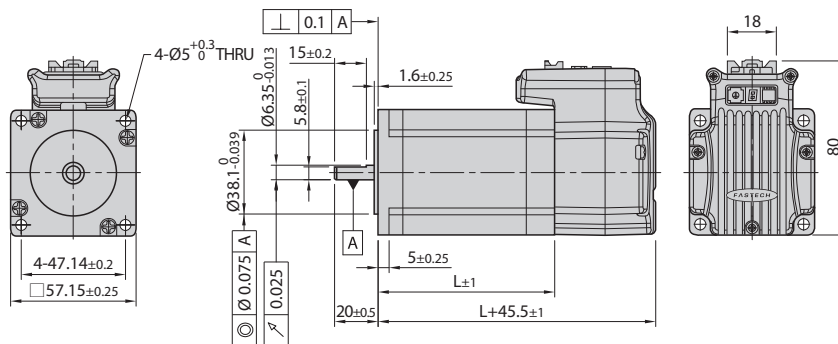

56mm

Model name	Length(L)
56S	46
56M	55
56L	80

※ There are 2 kinds size of front shaft diameter for Ezi-SERVO-ALL-56 series as Ø6.35 and Ø8.0.

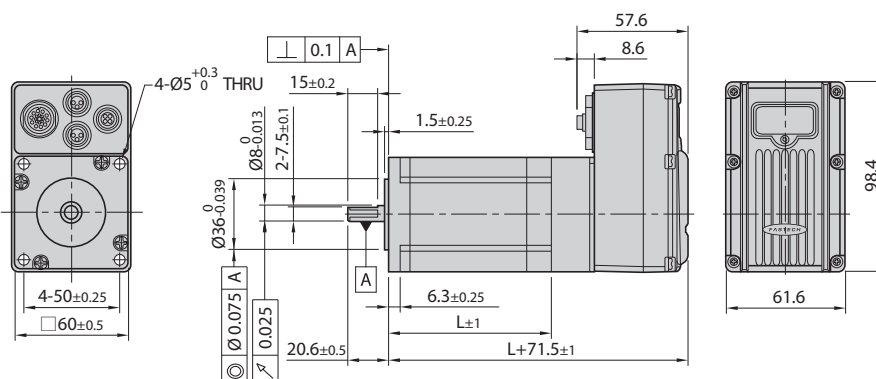

60mm

Model name	Length(L)
60S	47
60M	56
60L	85

● Specifications of Motor with Brake

Unit Part Number	Motor Model Number	Electronic Brake					Motor Unit Weight [g]	Permitted Overhung Load [N]				Permitted Thrust Load [N]
		Type	Voltage Input [V]	Rated Current [A]	Power Consumption [W]	Static Friction Torque [N·m]		Length from Motor Point [mm]				
								3	8	13	18	
Ezi-SERVO-ALL-42S-■-BK	Motor & Drive Integrated	Non-excitation run Type	24VDC ±10%	0,2	5	0,2	580	22	26	33	46	Must be Lower than Unit's Weight
Ezi-SERVO-ALL-42M-■-BK							650					
Ezi-SERVO-ALL-42L-■-BK							720					
Ezi-SERVO-ALL-42XL-■-BK							850					
Ezi-SERVO-ALL-56S-■-BK				0,27	6,6	0,7	1120	52	65	85	123	
Ezi-SERVO-ALL-56M-■-BK							1280					
Ezi-SERVO-ALL-56L-■-BK							1720					
Ezi-SERVO-ALL-60S-■-BK							1230					
Ezi-SERVO-ALL-60M-■-BK							1420					
Ezi-SERVO-ALL-60L-■-BK							2040					
	70	87	114	165								

- * The code of encoder resolution will be marked in "■"
- * Electronic Brake cannot be used for braking, Position hold purpose only when power OFF.
- * The weight means Motor Unit Weight including Motor and Electronic Brake.
- * Motor specification and torque characteristic are same as Standard Motor.

* Brake Operation Timing Chart

Ezi-SERVO-ALL-56/60-ABS series control Brake by Drive automatically.
 Please refer to below Timing Chart when control Brake from upper controller other than using Ezi-SERVO-ALL-56/60-ABS series Brake control.
 Otherwise, Drive malfunctioning and loads can be fall down.
 Also, please do not operate Brake while motor operation to prevent damage.
 Ezi-SERVO-ALL-28 series has no brake control function.

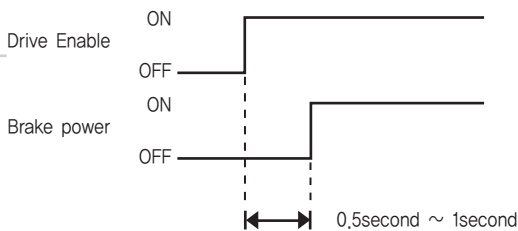

● Dimensions of Motor with Brake [mm]

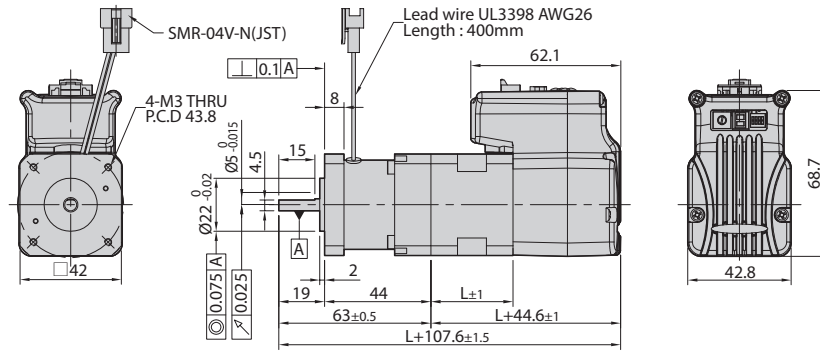

42mm

Model Name	Length(L)	Weight(kg)
42S	34	0.58
42M	40	0.65
42L	48	0.72
42XL	60	0.85

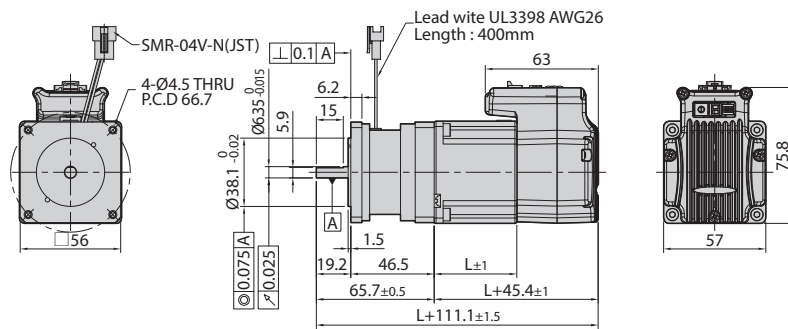

56mm

Model Name	Length(L)	Weight(kg)
56S	46	1.12
56M	55	1.28
56L	80	1.72

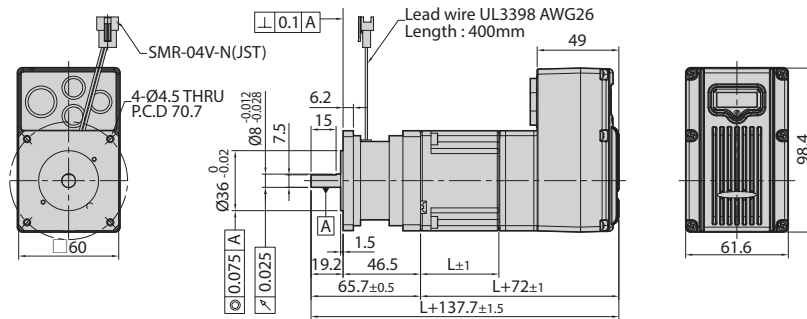

60mm

Model Name	Length(L)	Weight(kg)
60S	47	1.23
60M	56	1.42
60L	85	2.04

● Specifications of Motor with Gearbox

42mm

Unit Part Number	Maximum Holding Torque [N·m]	Rotor Inertia Moment [kg·m ²]	Back-lash [min]	Angle Transmission Error [min]	Reduction Gear Ratio	Resolution (10,000 [ppr] Standard)	Permitted Torque [N·m]	Maximum Torque [N·m]	Permitted Speed Range [rpm]	Unit Weight [kg]	Permitted Overhung Load [N]	Permitted Thrust Load [N]	
											Axis Center Standard		
Ezi-SERVO-ALL-42S-■-PN3	0,55	35x10 ⁻⁷	3	5	3	0,012°	6	12	0~1000	0,89	240	270	
Ezi-SERVO-ALL-42S-■-PN5	0,92				5	0,0072°	9	18	0~600		290	330	
Ezi-SERVO-ALL-42S-■-PN8	1,47				8	0,0045°	9	18	0~375		340	410	
Ezi-SERVO-ALL-42S-■-PN10	1,84				10	0,0036°	6	12	0~300		360	450	
Ezi-SERVO-ALL-42S-■-PN15	2,67		5	7	15	0,0024°	6	12	0~200	0,99	410	540	
Ezi-SERVO-ALL-42S-■-PN25	4,46				25	0,00144°	9	18	0~120		490	640	
Ezi-SERVO-ALL-42S-■-PN40	7,13				40	0,0009°	9	18	0~75		570	640	
Ezi-SERVO-ALL-42S-■-PN50	9,00				50	0,00072°	9	18	0~60		620	640	
Ezi-SERVO-ALL-42M-■-PN3	0,85		54x10 ⁻⁷	3	5	3	0,012°	6	12	0~1000	0,96	240	270
Ezi-SERVO-ALL-42M-■-PN5	1,42					5	0,0072°	9	18	0~600		290	330
Ezi-SERVO-ALL-42M-■-PN8	2,28	8				0,0045°	9	18	0~375	340		410	
Ezi-SERVO-ALL-42M-■-PN10	2,85	10				0,0036°	6	12	0~300	360		450	
Ezi-SERVO-ALL-42M-■-PN15	4,14	5		7	15	0,0024°	6	12	0~200	1,06	410	540	
Ezi-SERVO-ALL-42M-■-PN25	6,90				25	0,00144°	9	18	0~120		490	640	
Ezi-SERVO-ALL-42M-■-PN40	9,00				40	0,0009°	9	18	0~75		570	640	
Ezi-SERVO-ALL-42M-■-PN50	9,00				50	0,00072°	9	18	0~60		620	640	
Ezi-SERVO-ALL-42L-■-PN3	0,93	77x10 ⁻⁷		3	5	3	0,012°	6	12	0~1000	1,02	240	270
Ezi-SERVO-ALL-42L-■-PN5	1,55					5	0,0072°	9	18	0~600		290	330
Ezi-SERVO-ALL-42L-■-PN8	2,48		8			0,0045°	9	18	0~375	340		410	
Ezi-SERVO-ALL-42L-■-PN10	3,10		10			0,0036°	6	12	0~300	360		450	
Ezi-SERVO-ALL-42L-■-PN15	4,51		5	7	15	0,0024°	6	12	0~200	1,12	410	540	
Ezi-SERVO-ALL-42L-■-PN25	7,52				25	0,00144°	9	18	0~120		490	640	
Ezi-SERVO-ALL-42L-■-PN40	9,00				40	0,0009°	9	18	0~75		570	640	
Ezi-SERVO-ALL-42L-■-PN50	9,00				50	0,00072°	9	18	0~60		620	640	
Ezi-SERVO-ALL-42XL-■-PN3	1,42		114x10 ⁻⁷	3	5	3	0,012°	6	12	0~1000	1,15	240	270
Ezi-SERVO-ALL-42XL-■-PN5	2,38					5	0,0072°	9	18	0~600		290	330
Ezi-SERVO-ALL-42XL-■-PN8	3,80	8				0,0045°	9	18	0~375	340		410	
Ezi-SERVO-ALL-42XL-■-PN10	4,76	10				0,0036°	6	12	0~300	360		450	
Ezi-SERVO-ALL-42XL-■-PN15	6,00	5		7	15	0,0024°	6	12	0~200	1,25	410	540	
Ezi-SERVO-ALL-42XL-■-PN25	9,00				25	0,00144°	9	18	0~120		490	640	
Ezi-SERVO-ALL-42XL-■-PN40	9,00				40	0,0009°	9	18	0~75		570	640	
Ezi-SERVO-ALL-42XL-■-PN50	9,00				50	0,00072°	9	18	0~60		620	640	

* The code of encoder resolution will be marked in "■"

● Specifications of Motor with Gearbox

56_{mm}

Unit Part Number	Maximum Holding Torque [N·m]	Rotor Inertia Moment [kg·m ²]	Back-lash [min]	Angle Transmission Error [min]	Re-duction Gear Ratio	Resolution (10,000 [ppr] Standard)	Permitted Torque [N·m]	Maximum Torque [N·m]	Permitted Speed Range [rpm]	Unit Weight [kg]	Permitted Overhung Load [N]	Permitted Thrust Load [N]	
											Axis Center Standard		
Ezi-SERVO-ALL-56S-■-PN3	1	180x10 ⁻⁷	3	5	3	0,012°	18	35	0~1000	1,94	430	310	
Ezi-SERVO-ALL-56S-■-PN5	1,7										510	390	
Ezi-SERVO-ALL-56S-■-PN8	2,8										600	480	
Ezi-SERVO-ALL-56S-■-PN10	3,5										640	530	
Ezi-SERVO-ALL-56S-■-PN15	5,1										2,14	740	630
Ezi-SERVO-ALL-56S-■-PN25	8,6											870	790
Ezi-SERVO-ALL-56S-■-PN40	13,8											1000	970
Ezi-SERVO-ALL-56S-■-PN50	17,2											1100	1100
Ezi-SERVO-ALL-56M-■-PN3	2,0	280x10 ⁻⁷	3	5	3	0,012°	18	35	0~1000	2,15	430	310	
Ezi-SERVO-ALL-56M-■-PN5	3,4										510	390	
Ezi-SERVO-ALL-56M-■-PN8	5,5										600	480	
Ezi-SERVO-ALL-56M-■-PN10	6,9										640	530	
Ezi-SERVO-ALL-56M-■-PN15	10										2,35	740	630
Ezi-SERVO-ALL-56M-■-PN25	16,7											870	790
Ezi-SERVO-ALL-56M-■-PN40	27,0											1000	970
Ezi-SERVO-ALL-56M-■-PN50	27,0											1100	1100
Ezi-SERVO-ALL-56L-■-PN3	3,6	520x10 ⁻⁷	3	5	3	0,012°	18	35	0~1000	2,55	430	310	
Ezi-SERVO-ALL-56L-■-PN5	6										510	390	
Ezi-SERVO-ALL-56L-■-PN8	9,7										600	480	
Ezi-SERVO-ALL-56L-■-PN10	12,1										640	530	
Ezi-SERVO-ALL-56L-■-PN15	18,0										2,75	740	630
Ezi-SERVO-ALL-56L-■-PN25	27,0											870	790
Ezi-SERVO-ALL-56L-■-PN40	27,0											1000	970
Ezi-SERVO-ALL-56L-■-PN50	27,0											1100	1100

* The code of encoder resolution will be marked in "■"

FASTECH Ezi-SERVO ALL

● Specifications of Motor with Gearbox

60mm

Unit Part Number	Maximum Holding Torque [N·m]	Rotor Inertia Moment [kg·m ²]	Back-lash [min]	Angle Transmission Error [min]	Reduction Gear Ratio	Resolution (10,000 [ppr] Standard)	Permitted Torque [N·m]	Maximum Torque [N·m]	Permitted Speed Range [rpm]	Unit Weight [kg]	Permitted Overhung Load [N]	Permitted Thrust Load [N]	
											Axis Center Standard		
Ezi-SERVO-ALL-60S-■-PN3	1,6	240x10 ⁻⁷	3	5	3	0,012°	18	35	0~1000	2,0	430	310	
Ezi-SERVO-ALL-60S-■-PN5	2,7										510	390	
Ezi-SERVO-ALL-60S-■-PN8	4,4										600	480	
Ezi-SERVO-ALL-60S-■-PN10	5,5										640	530	
Ezi-SERVO-ALL-60S-■-PN15	8										2,2	740	630
Ezi-SERVO-ALL-60S-■-PN25	13,4											870	790
Ezi-SERVO-ALL-60S-■-PN40	21,4											1000	970
Ezi-SERVO-ALL-60S-■-PN50	26,8											1100	1100
Ezi-SERVO-ALL-60M-■-PN3	2,6	490x10 ⁻⁷	3	5	3	0,012°	18	35	0~1000	2,0	430	310	
Ezi-SERVO-ALL-60M-■-PN5	4,4										510	390	
Ezi-SERVO-ALL-60M-■-PN8	7,0										600	480	
Ezi-SERVO-ALL-60M-■-PN10	8,8										640	530	
Ezi-SERVO-ALL-60M-■-PN15	12,8										2,2	740	630
Ezi-SERVO-ALL-60M-■-PN25	21,4											870	790
Ezi-SERVO-ALL-60M-■-PN40	27,0											1000	970
Ezi-SERVO-ALL-60M-■-PN50	27,0											1100	1100
Ezi-SERVO-ALL-60L-■-PN3	4,9	690x10 ⁻⁷	3	5	3	0,012°	18	35	0~1000	3,0	430	310	
Ezi-SERVO-ALL-60L-■-PN5	8,3										510	390	
Ezi-SERVO-ALL-60L-■-PN8	13,2										600	480	
Ezi-SERVO-ALL-60L-■-PN10	16,6										640	530	
Ezi-SERVO-ALL-60L-■-PN15	18,0										3,2	740	630
Ezi-SERVO-ALL-60L-■-PN25	27,0											870	790
Ezi-SERVO-ALL-60L-■-PN40	27,0											1000	970
Ezi-SERVO-ALL-60L-■-PN50	27,0											1100	1100

* The code of encoder resolution will be marked in "■"

● Dimensions of Motor with Gearbox [mm]

42mm

Unit Part Number	Motor	Stage	□ Reduction Gear Ratio	L Length [mm]
Ezi-SERVO-ALL-42S-■-PN□	Motor & Drive Integrated	Single Stage	3, 5, 8, 10	34
Ezi-SERVO-ALL-42M-■-PN□			3, 5, 8, 10	40
Ezi-SERVO-ALL-42L-■-PN□			3, 5, 8, 10	48
Ezi-SERVO-ALL-42XL-■-PN□			3, 5, 8, 10	60

* The code of encoder resolution will be marked in "■"

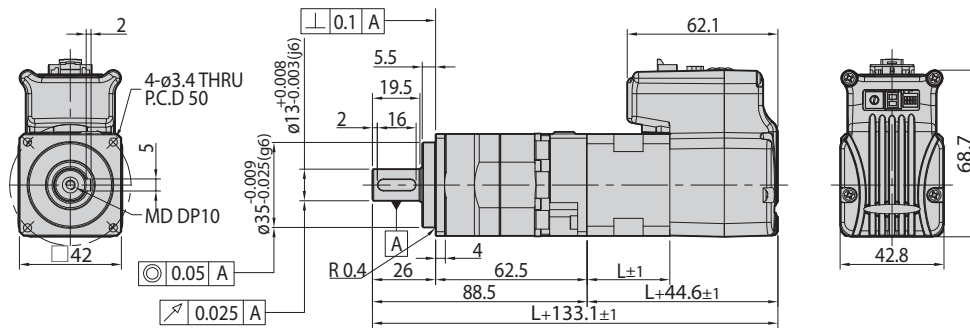

Unit Part Number	Motor	Stage	□ Reduction Gear Ratio	L Length [mm]
Ezi-SERVO-ALL-42S-■-PN□	Motor & Drive Integrated	Double Stage	15, 25, 40, 50	34
Ezi-SERVO-ALL-42M-■-PN□			15, 25, 40, 50	40
Ezi-SERVO-ALL-42L-■-PN□			15, 25, 40, 50	48
Ezi-SERVO-ALL-42XL-■-PN□			15, 25, 40, 50	60

* The code of encoder resolution will be marked in "■"

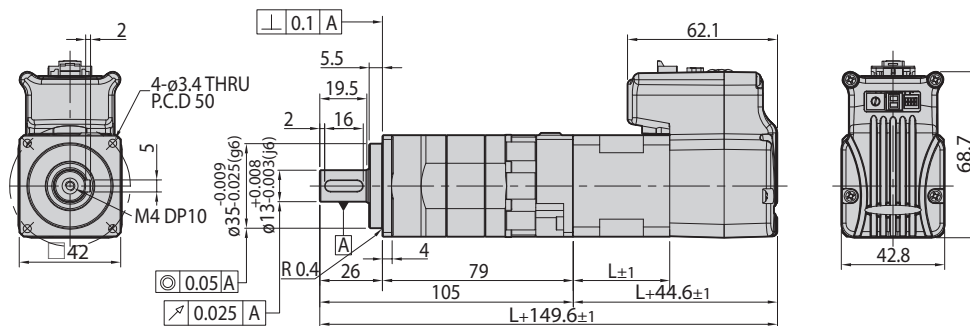

● Dimensions of Motor with Gearbox [mm]

56_{mm}

Unit Part Number	Motor	Stage	□ Reduction Gear Ratio	L Length [mm]
Ezi-SERVO-ALL-56S-■-PN□	Motor & Drive Integrated	Single Stage	3, 5, 8, 10	46
Ezi-SERVO-ALL-56M-■-PN□			3, 5, 8, 10	55
Ezi-SERVO-ALL-56L-■-PN□			3, 5, 8, 10	80

* The code of encoder resolution will be marked in "■"

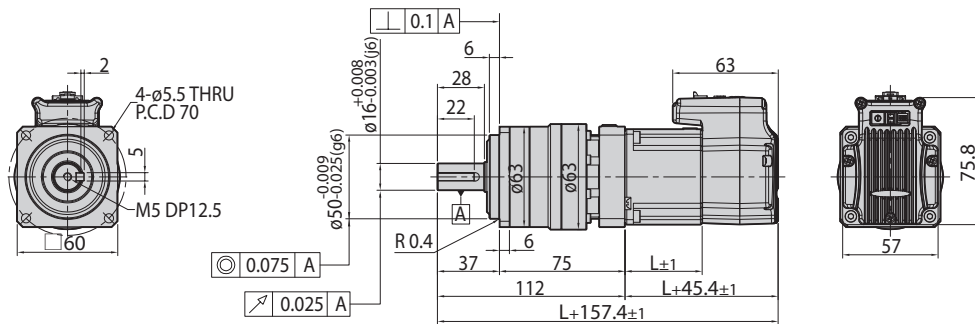

Unit Part Number	Motor	Stage	□ Reduction Gear Ratio	L Length [mm]
Ezi-SERVO-ALL-56S-■-PN□	Motor & Drive Integrated	Double Stage	15, 25, 40, 50	46
Ezi-SERVO-ALL-56M-■-PN□			15, 25, 40, 50	55
Ezi-SERVO-ALL-56L-■-PN□			15, 25, 40, 50	80

* The code of encoder resolution will be marked in "■"

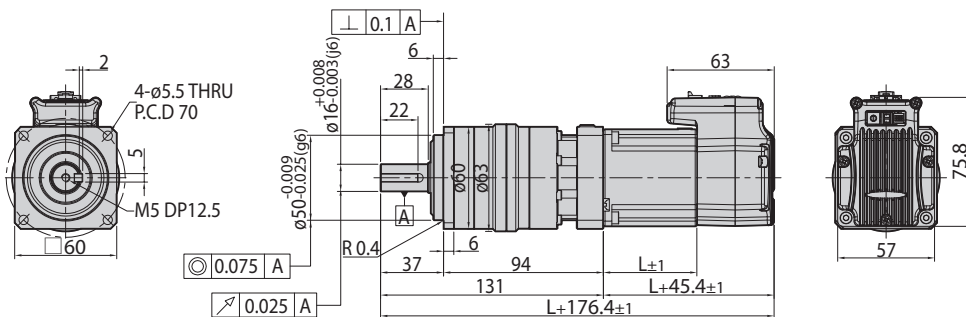

● Dimensions of Motor with Gearbox [mm]

60_{mm}

Unit Part Number	Motor	Stage	□ Reduction Gear Ratio	L Length [mm]
Ezi-SERVO-ALL-60S-■-PN□	Motor & Drive Integrated	Single Stage	3, 5, 8, 10	47
Ezi-SERVO-ALL-60M-■-PN□			3, 5, 8, 10	56
Ezi-SERVO-ALL-60L-■-PN□			3, 5, 8, 10	85

* The code of encoder resolution will be marked in "■"

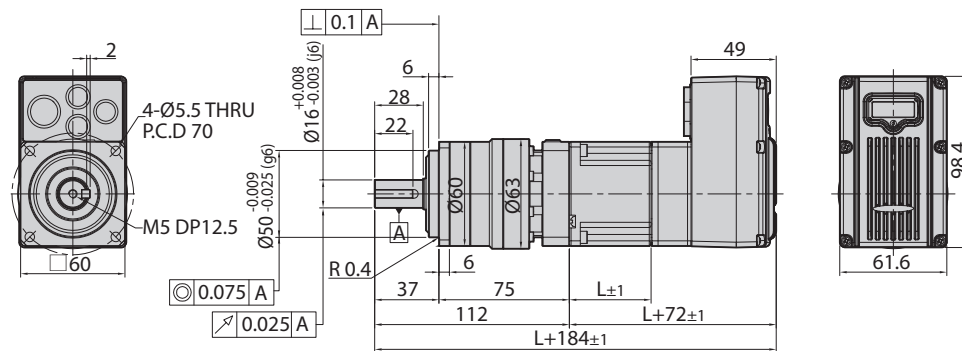

Unit Part Number	Motor	Stage	□ Reduction Gear Ratio	L Length [mm]
Ezi-SERVO-ALL-60S-■-PN□	Motor & Drive Integrated	Double Stage	15, 25, 40, 50	47
Ezi-SERVO-ALL-60M-■-PN□			15, 25, 40, 50	56
Ezi-SERVO-ALL-60L-■-PN□			15, 25, 40, 50	85

* The code of encoder resolution will be marked in "■"

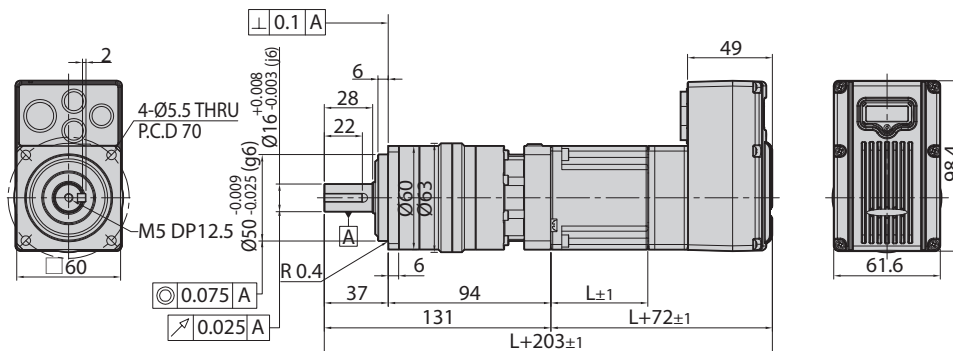

● Specifications of Drive [Ezi-SERVO-ALL-28 series]





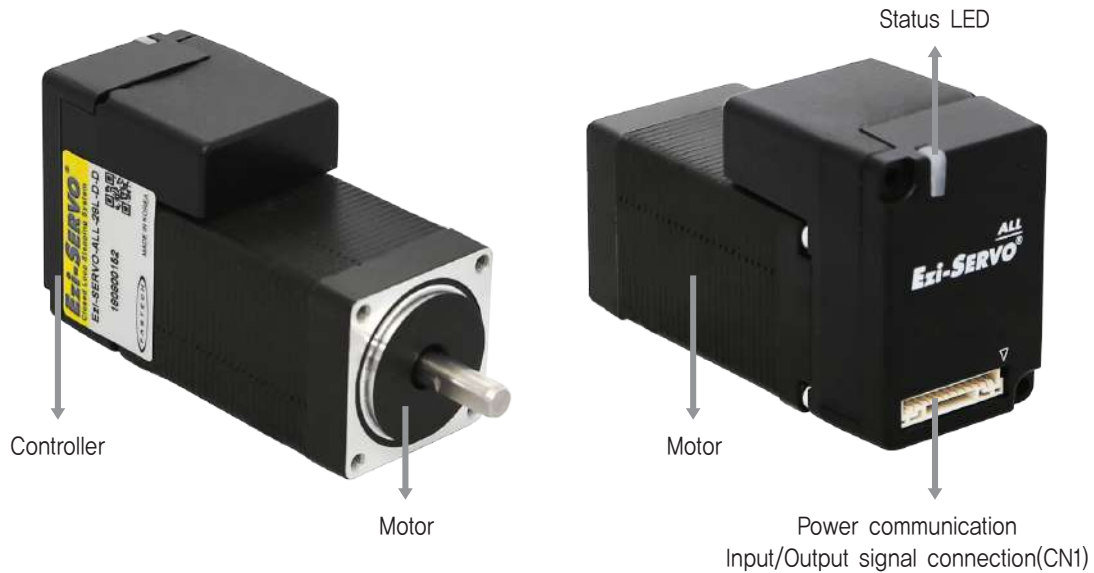







Model		Ezi-SERVO-ALL-28 series
Input Voltage		24VDC \pm 10%
Control Method		Closed loop control with 32bit ARM
Multi Axes Drive		Maximum 16 axes through Star Topology
Position Table		Does not support
Current Consumption		Max 500mA (Except motor current)
Operating Condition	Ambient Temperature	· In Use: 0~50°C · In Storage: -20~70°C
	Humidity	· In Use: 35~85% RH (Non-Condensing) · In Storage: 10~90% RH (Non-Condensing)
	Vib. Resist.	0.5g
Function	Rotation Speed	0~3,000 [rpm]
	Resolution [ppr]	500 1,000 1,600 2,000 3,600 5,000 6,400 7,200 10,000 16,000 (Selectable by parameter)
	Protection Functions	Over Current Error, Over Speed Error, Position Tracking Error, Over Load Error, Over Temperature Error, Over Regenerated Voltage Error, Motor Connect Error, Encoder Connect Error, In-Position Error, ROM Error, Position Overflow Error
	In-Position Selection	0~63 (Selectable by parameter)
	Position Gain Selection	0~63 (Selectable by parameter)
I/O Signal	Rotational Direction	CW/CCW (Selectable by parameter)
	Input Signals	3 dedicated inputs (LIMIT+, LIMIT-, ORIGIN), 1 programmable input (Photocoupler, NPN/PNP input support)
Output Signals		Does not support
Communication Interface		RS-485 serial communication Communication speed: 112,500 [bps]
Position Control		· Incremental mode / Absolute mode Data Range: -2,147,483,648 to +2,147,483,647 [pulse] · Operating speed: Max. 3,000 [rpm]
Return to Origin		Origin Sensor, Z phase, \pm Limit sensor, Torque
GUI		User Interface Program within Windows
Software		Motion Library (DLL) for Windows XP/7/8/10

● Settings and Operation [Ezi-SERVO-ALL-28 series]



1. Status LED

In the case of Ezi-SERVO-ALL-28 series products, LED can be checked by LED color, lighting, On/Off and blinking.

Status	LED	Description
Disable	Green :  Red : 	Green light flashing, Red light off
Enable	Green :  Red : 	Green light on, Red light off
Enable & Communication	Green :  Red : 	Green light on, Rlight flashing
In motion	Green :  Red : 	Green light on, Red light on
In-position deviation	Green :  Red : 	Green and Red light alternately flashing
Alarm	Green :  Red : 	Red light flashing repeatedly as many as alarm number

◆ Protection functions and LED flash times

Times	Protection	Conditions
1	Over Current Error	The current through power devices in inverter exceeds the 4.8A
2	Over Speed Error	Motor speed exceeds 3,000 [rpm]
3	Position Tracking Error	Position error value is higher than 90° in motor run status *1
4	Over Load Error	The motor is continuously operated more than 5 seconds under a load exceeding the max. torque
5	Over Temperature Error	Inside temperature of drive is abnormally high
6	Over Regenerative Voltage Error	Back-EMF is higher than 48V
7	Motor Connect Error	The power is ON without connection of the motor cable to drive
8	Encoder Connect Error	Cable connection error with Encoder connection in drive
10	In-Position Error	After operation is finished, a position error occurs
12	ROM Error	Error occurs during tuning execution
15	Position Overflow Error	Position error value is higher than 90° in motor stop state *1

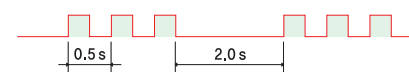

Alarm LED flash
(Ex, Position tracking error)

*1 : Default value can be changed by parameter(Refer of the Manual)

2. Termination Setting

When pin 9 and pin 10 of the connector(CN1) are connected externally, the drive is set to the end of the network. If the drive is connected to the end of the communication network, set it to the termination.

3. Network ID Setting

The network ID of Ezi-SERVO-ALL-28 series can be set using Ezi-MOTION Plus-R GUI (Version 6.40,7.12 or later). After connecting the communication, the setting window appears by selecting the product and press the right button of the mouse.

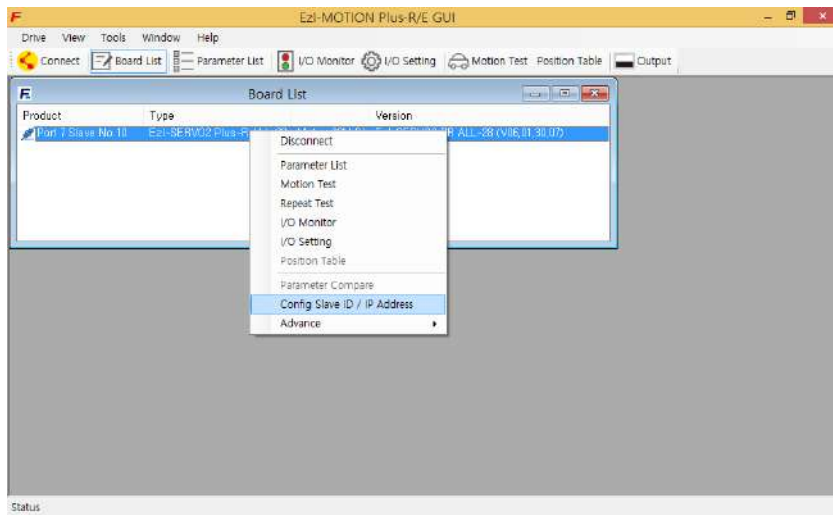

4. Power Communication Input/Output Signal Connector(CN1)

NO.	Function	I/O
1	GND	Input
2	24VDC	Input
3	IO COMMON	Input
4	ORIGIN	Input
5	LIMIT+	Input
6	LIMIT-	Input
7	IN1	Input
9	Termination	Input
10	Data-	Communication
11	Data+	Communication
12	S-GND	Input

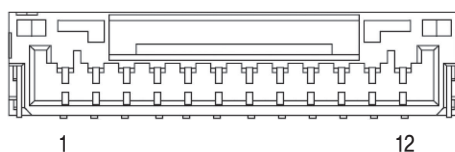

● System Configuration [Ezi-SERVO-ALL-28 series]

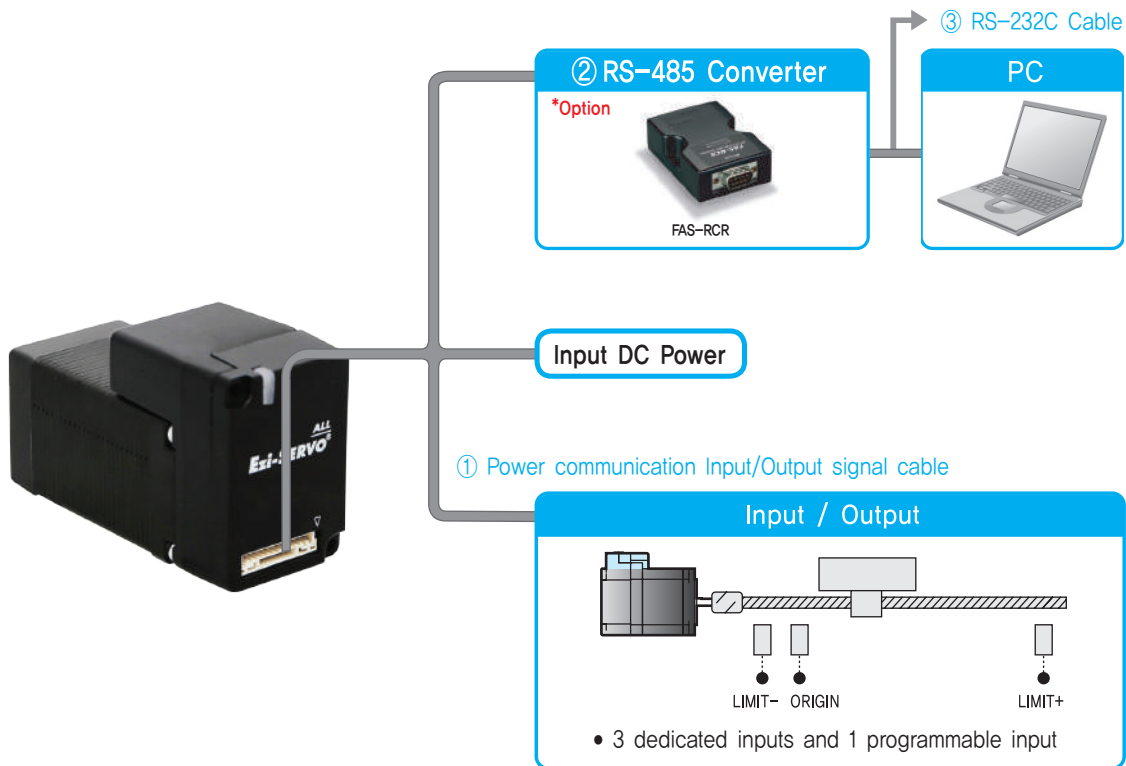

Type	Signal Cable	Power Cable	RS-485 Cable
Length supplied	—	—	—
Max. Length	20m	2m	30m

1. Options

① Power Communication Input/Output Signal Cable

Available to connect between Control System and Ezi-SERVO-ALL-28.
(It is provided item as standard option)

Item	Length [m]	Remark
CSVA-A-OR4F	0,4	Normal Cable

※ This cable is provide item as standard option.

② FAS-RCR(RS-232C to RS-485 Converter)

Item	Specification
Comm. Speed	Max. 115,2 [kbps]
Comm. Distance	RS-232C: Max. 15m RS-485: Max. 1,2km
Connection Type	RS-232C: DB9 Female RS-485: RJ-45
Dimension	50×75×23mm
Weight	38g
Power	Powered from PC (Usable for external DC5~24V)

③ RS-232C Cable

Available to connect between RS-232C port of master and FAS-RCR.

Item	Length [m]	Remark
CGNR-C-002F	2	Normal Cable
CGNR-C-003F	3	
CGNR-C-005F	5	

2. Connector Specifications

Connector specifications for cabling to drive.

Purpose	Item	Part Number	Manufacturer
Signal	Housing Terminal	GHR-12V-S SSHL-005T-P0,2	JST

※ Above connector is the most suitable product for the drive applied. Another equivalent connector can be used.

● External Wiring Diagram [Ezi-SERVO-ALL-28 series]

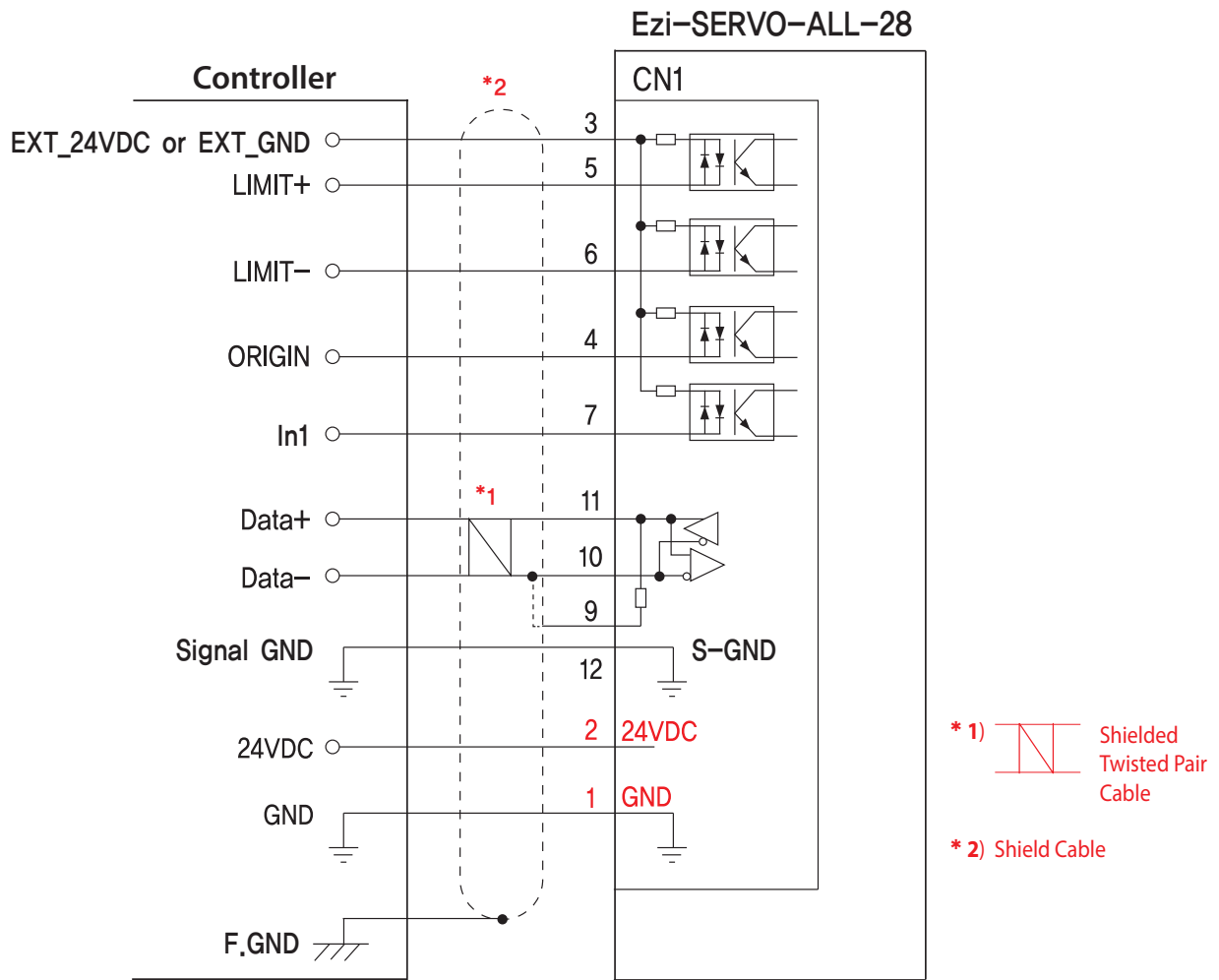

FASTECH Ezi-SERVO ALL

※ When connects I/O cable between controller and drive, please turn off the power of both controller and drive, in order to protect the drive from any damage.

● Specifications of Drive [Ezi-SERVO-ALL-42/56 series]

Model		Ezi-SERVO-ALL-42 series	Ezi-SERVO-ALL-56 series
Input Voltage		24VDC ±10%	
Control Method		Closed loop control with 32bit DSP	
Multi Axes Drive		Maximum 16 axes through Daisy-Chain	
Position Table		64 motion command steps (Continuous, Wait, Loop, Jump and External start etc.)	
Current Consumption		Max 500mA (Except motor current)	
Operating Condition	Ambient Temperature	<ul style="list-style-type: none"> · In Use: 0~55°C · In Storage: -20~70°C 	
	Humidity	<ul style="list-style-type: none"> · In Use: 35~85% RH (Non-Condensing) · In Storage: 10~90% RH (Non-Condensing) 	
	Vib. Resist.	0.5g	
Function	Rotation Speed	0~3,000 [rpm] *1	
	Resolution [ppr]	10,000/Rev. Encoder model: 500 1,000 1,600 2,000 3,600 5,000 6,400 7,200 10,000 20,000/Rev. Encoder model: 500 1,000 1,600 2,000 3,600 5,000 6,400 7,200 10,000 20,000 (Selectable by parameter)	
	Protection Functions	Over Current Error, Over Speed Error, Position Tracking Error, Over Load Error, Over Temperature Error, Over Regenerated Voltage Error, Motor Connect Error, Encoder Connect Error, In-Position Error, System Error, ROM Error, Position Overflow Error	
	In-Position Selection	0~15 (Selectable by parameter)	
	Position Gain Selection	0~15 (Selectable by parameter)	
	Rotational Direction	CW/CCW (Selectable by parameter)	
I/O Signal	Input Signals	3 dedicated inputs (LIMIT+, LIMIT-, ORIGIN), 7 programmable inputs (Photocoupler)	
	Output Signals	1 dedicated output (Compare Out), 1 programmable output (Photocoupler), Brake	
Communication Interface		RS-485 serial communication Communication speed: 9,600~921,600 [bps]	
Position Control		<ul style="list-style-type: none"> · Incremental mode / Absolute mode Data Range: -134,217,728 to +134,217,727 [pulse] · Operating speed: Max. 3,000 [rpm] *1 	
Return to Origin		Origin Sensor, Z phase, ±LIMIT sensor	
GUI		User Interface Program within Windows	
Software		Motion Library (DLL) for Windows XP/7/8/10	

*1 : Up to the resolution of 10,000[ppr], maximum speed can be reached by 3,000[rpm] and with the resolution more than 10,000[ppr], maximum speed shall be reduced accordingly.

● Settings and Operation [Ezi-SERVO-ALL-42/56 series]

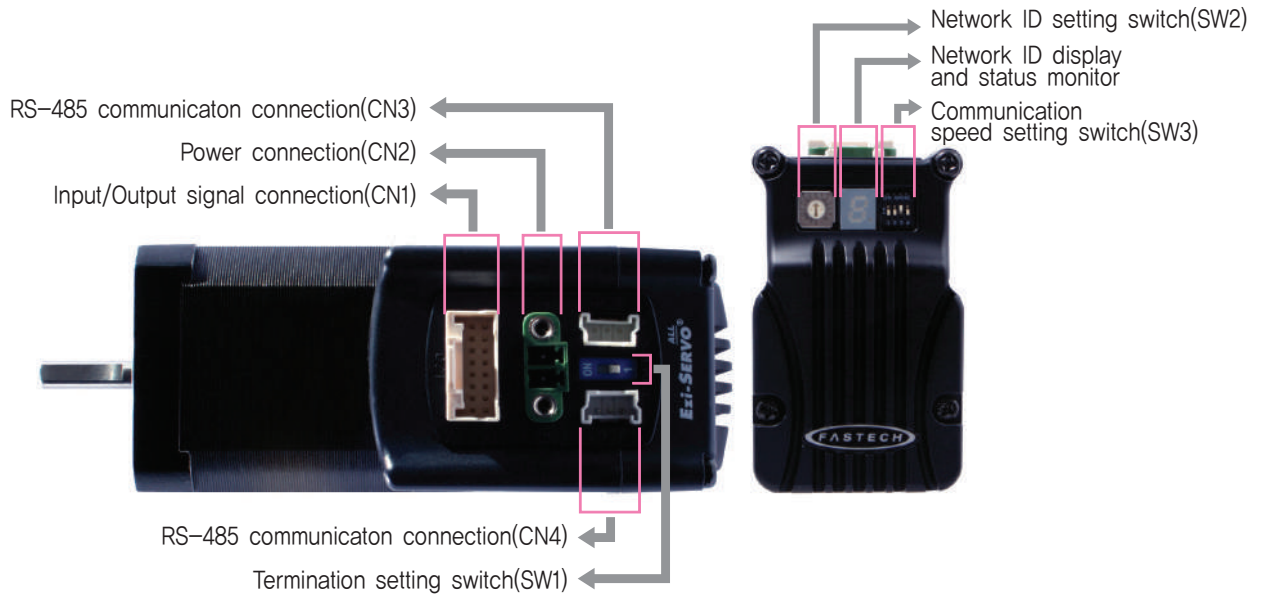

◆ Protection functions and 7-Segment flash times

When Alarm occurs, can recognize main reason of alarming thru by 7-Segment flash times which indicates Network ID.

Times	Protection	Conditions
1	Over Current Error	The current through power devices in inverter exceeds the 4,8A
2	Over Speed Error	Motor speed exceed 3,000rpm
3	Position Tracking Error	Position error value is higher than 90° in motor run state *1
4	Over Load Error	The motor is continuously operated more than 5 seconds under a load exceeding the max, torque
5	Over Temperature Error	Inside temperature of drive exceeds 85°C
6	Over Regenerated Voltage Error	Back-EMF is more than 48V value
7	Motor Connect Error	The power is ON without connection of the motor cable to drive
8	Encoder Connect Error	Cable connection error with Encoder connection in drive
10	In-Position Error	After operation is finished, a position error occurs
12	ROM Error	Error occurs during tuning execution
15	Position Overflow Error	Position error value is higher than 90° in motor stop state *1

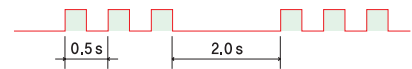

7-Segment flash
(Ex, Position tracking error)

*1 : Default value can be changed by parameter(Refer of the Manual)

FASTECH Ezi-SERVO ALL

1. Termination Setting Switch(SW1)

The drive installed at the end of the network must be terminated for reliable operation. Please termination setting switch is ON if drive installed at the end of the network.

2. Network ID Setting Switch(SW2)

Position	ID Number	Position	ID Number
0	0	8	8
1	1	9	9
2	2	A	10
3	3	B	11
4	4	C	12
5	5	D	13
6	6	E	14
7	7	F	15

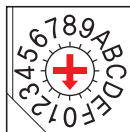

※ Maximum 16 axis can be connected in one network.

3. Communication Speed Setting Switch(SW3)

The purpose of this is to setting the communication speed

SW3.1	SW3.2	SW3.3	Baud Rate [bps]
OFF	OFF	OFF	9,600
ON	OFF	OFF	19,200
OFF	ON	OFF	38,400
ON	ON	OFF	57,600
OFF	OFF	ON	115,200*1
ON	OFF	ON	230,400
OFF	ON	ON	460,800
ON	ON	ON	921,600

*1 : Default setting value

*2 : SW3.4 is not available to use

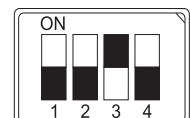

4. Input/Output Signal Connector(CN1)

NO.	Function	I/O
1	EXT_24VDC	Input
2	EXT_GND	Input
3	BRAKE+	Output
4	BRAKE-	Output
5	LIMIT+	Input
6	LIMIT-	Input
7	ORIGIN	Input
8	Digital In1	Input
9	Digital In2	Input
10	Digital In3	Input
11	Digital In4	Input
12	Digital In5	Input
13	Digital In6	Input
14	Digital In7	Input
15	Compare Out	Output
16	Digital Out1	Output

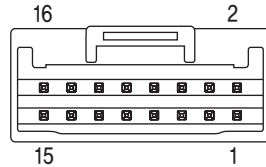

5. Power Connector(CN2)

NO.	Function	I/O
1	24VDC	Input
2	GND	Input

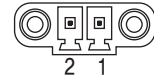

6. RS-485 Communication Connector(CN3, CN4)

NO.	Function
1	Data+
2	Data-
3	GND

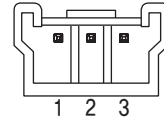

System Configuration [Ezi-SERVO-ALL-42/56 series]

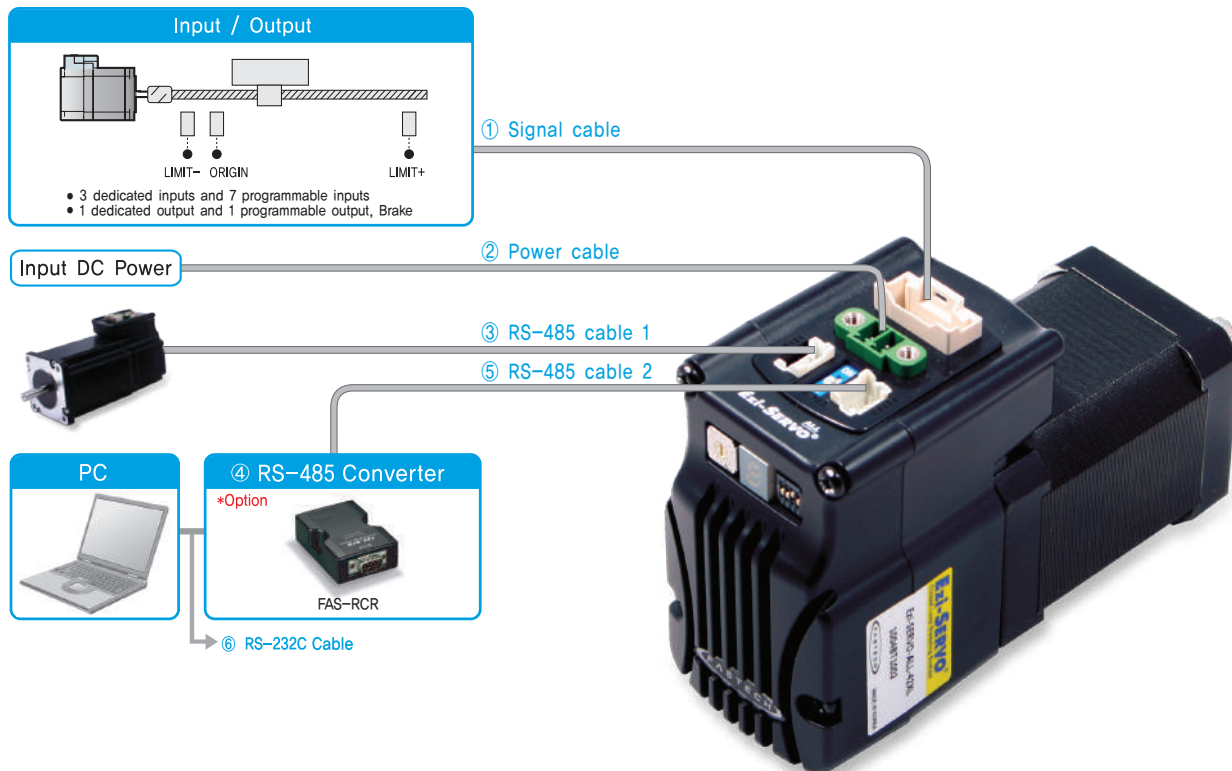

Type	Signal Cable	Power Cable	RS-485 Cable
Length supplied	-	-	-
Max. Length	20m	2m	30m

1. Options

① Signal Cable

Available to connect between Input/Output signals and Ezi-SERVO-ALL-42/56.

Item	Length [m]	Remark
CSVA-S-□□□F	□□□	Normal Cable
CSVA-S-□□□M	□□□	Robot Cable

□ is for Cable Length. The unit is 1m and Max, 20m length.

② Power Cable

Available to connect between Power and Ezi-SERVO-ALL-42/56.

Item	Length [m]	Remark
CSVA-P-□□□F	□□□	Normal Cable
CSVA-P-□□□M	□□□	Robot Cable

□ is for Cable Length. The unit is 1m and Max, 2m length.

③ RS-485 Cable 1

Common cable to connect Ezi-SERVO-ALL-42/56, Ezi-STEP-ALL-42/56, Ezi-MOTIONLINK Plus-R and Ezi-SERVO Plus-R MINI thru by Network.

Item	Length [m]	Remark
CGNB-R-0R6F	0,6	Normal Cable
CGNB-R-001F	1	
CGNB-R-1R5F	1,5	
CGNB-R-002F	2	
CGNB-R-003F	3	
CGNB-R-005F	5	

④ FAS-RCR(RS-232C to RS-485 Converter)

Item	Specification
Comm. Speed	Max, 115,2 [kbps]
Comm. Distance	RS-232C: Max, 15m RS-485: Max, 1,2km
Connection Type	RS-232C: DB9 Female RS-485: RJ-45
Dimension	50×75×23mm
Weight	38g
Power	Powered from PC (Usable for external DC5~24V)

⑤ RS-485 Cable 2

RCR to Ezi-SERVO-ALL-42/56, FAS-RCR to Ezi-STEP-ALL-42/56, FAS-RCR to Ezi-SERVO Plus-R MINI, FAS-RCR to Ezi-MOTIONLINK Plus-R

Item	Length [m]	Remark
CGNA-R-0R6F	0,6	Normal Cable
CGNA-R-001F	1	
CGNA-R-1R5F	1,5	
CGNA-R-002F	2	
CGNA-R-003F	3	
CGNA-R-005F	5	

⑥ RS-232C Cable

Available to connect between RS-232C port of master and FAS-RCR.

Item	Length [m]	Remark
CGNR-C-002F	2	Normal Cable
CGNR-C-003F	3	
CGNR-C-005F	5	

2. Connector Specifications

Connector specifications for cabling to drive.

Purpose	Item	Part Number	Manufacturer
Power (CN2)	Terminal Block	AKZ1550/2F-3,81	PTR
Signal (CN1)	Housing Terminal	501646-1600 501648-1000(AWG 26~28)	MOLEX
RS-485 Communication (CN3, CN4)	Housing Terminal	35507-0300 50212-8100	MOLEX

※ Above connector is the most suitable product for the drive applied. Another equivalent connector can be used.

● External Wiring Diagram [Ezi-SERVO-ALL-42/56 series]

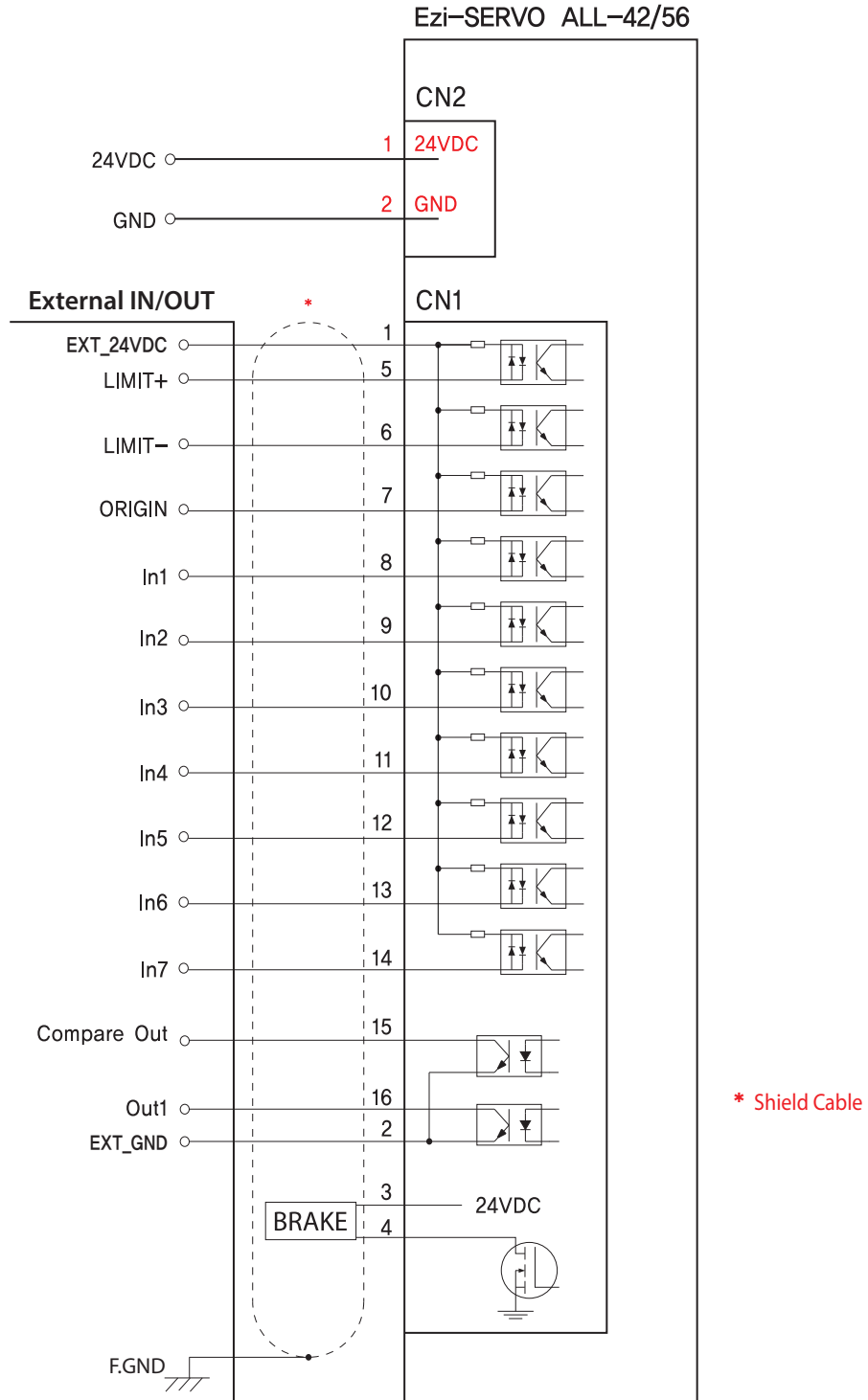

※ When connects I/O cable between controller and drive, please turn off the power of both controller and drive, in order to protect the drive from any damage.

● Specifications of Drive [Ezi-SERVO-ALL-60/60-ABS series]

Model		Ezi-SERVO-ALL-60 series	Ezi-SERVO-ALL-60-ABS series
Input Voltage		24VDC \pm 10%	
Control Method		Closed loop control with 32bit DSP	
Multi Axes Drive		Maximum 16 axes through Daisy-Chain	
Position Table		64 motion command steps (Continuous, Wait, Loop, Jump and External start etc.)	
Current Consumption		Max 500mA (Except motor current)	
Operating Condition	Ambient Temperature	<ul style="list-style-type: none"> · In Use: 0~55°C · In Storage: -20~70°C 	
	Humidity	<ul style="list-style-type: none"> · In Use: 35~85% RH (Non-Condensing) · In Storage: 10~90% RH (Non-Condensing) 	
	Vib. Resist.	0.5g	
Function	Rotation Speed	0~3,000 [rpm] *1	
	Resolution [ppr]	<ul style="list-style-type: none"> · 10,000/Rev, Encoder model: 500 1,000 1,600 2,000 3,600 5,000 6,400 7,200 10,000 · 20,000/Rev, Encoder model: 500 1,000 1,600 2,000 3,600 5,000 6,400 7,200 10,000 20,000 (Selectable by parameter) 	<ul style="list-style-type: none"> · 500 1,000 1,600 2,000 3,600 5,000 6,400 7,200 10,000 (Selectable by parameter)
	Protection Functions	Over Current Error, Over Speed Error, Position Tracking Error, Over Load Error, Over Temperature Error, Over Regenerated Voltage Error, Motor Connect Error, Encoder Connect Error, In-Position Error, System Error, ROM Error, Position Overflow Error	
	In-Position Selection	0~15 (Selectable by parameter)	
	Position Gain Selection	0~15 (Selectable by parameter)	
	Rotational Direction	CW/CCW (Selectable by parameter)	
I/O Signal	Input Signals	3 dedicated inputs (LIMIT+, LIMIT-, ORIGIN), 7 programmable inputs (Photocoupler)	3 dedicated inputs (LIMIT+, LIMIT-, ORIGIN), 6 programmable inputs (Photocoupler)
	Output Signals	1 dedicated output (Compare Out), 3 programmable outputs (Photocoupler), Brake	6 programmable outputs (Photocoupler), Brake
Communication Interface		RS-485 serial communication Communication speed: 9,600~921,600 [bps]	RS-485 serial communication Communication speed: 115,200 [bps]
Position Control		<ul style="list-style-type: none"> · Incremental mode / Absolute mode Data Range: -134,217,728 to +134,217,727 [pulse] · Operating speed: Max. 3,000 [rpm] *1 	
Return to Origin		Origin Sensor, Z phase, \pm LIMIT sensor	
GUI		User Interface Program within Windows	
Software		Motion Library (DLL) for Windows XP/7/8/10	

*1 : Up to the resolution of 10,000[ppr], maximum speed can be reached by 3,000[rpm] and with the resolution more than 10,000[ppr], maximum speed shall be reduced accordingly.

● Settings and Operation [Ezi-SERVO-ALL-60/60-ABS series]

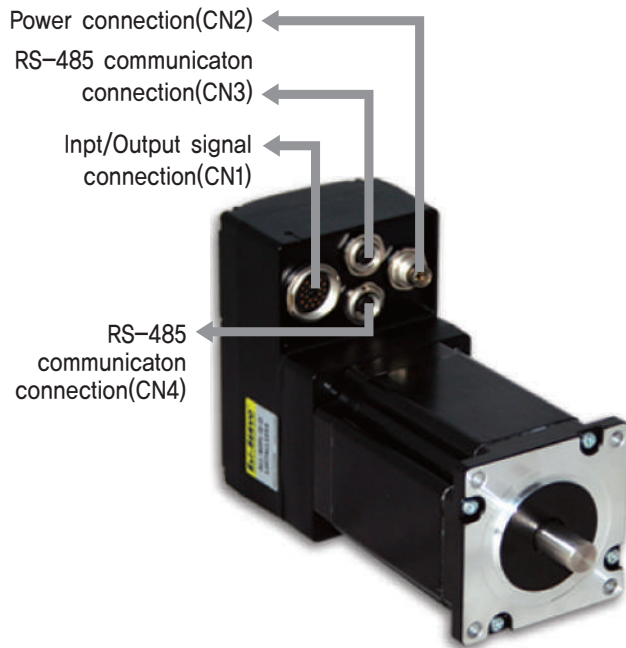

◆ Ezi-SERVO-ALL-60-ABS series

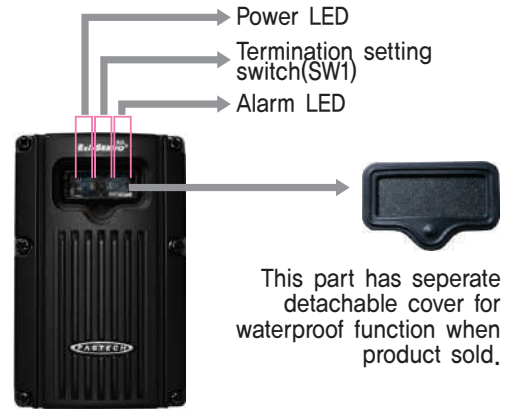

◆ Ezi-SERVO-ALL-60 series

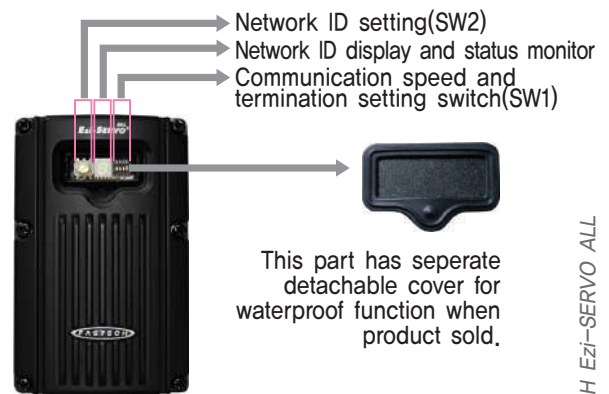

◆ Protection functions and LED or 7-Segment flash times

When Alarm occurs, can recognize main reason of alarming thru by LED or 7-Segment flash times.

Times	Protection	Conditions
1	Over Current Error	The current through power devices in inverter exceeds the 4.8A
2	Over Speed Error	Motor speed exceed 3,000 [rpm]
3	Position Tracking Error	Position error value is higher than 90° in motor run state *1
4	Over Load Error	The motor is continuously operated more than 5 seconds under a load exceeding the max. torque
5	Over Temperature Error	Inside temperature of drive exceeds 85°C
6	Over Regenerated Voltage Error	Back-EMF is more than 48V value
7	Motor Connect Error	The power is ON without connection of the motor cable to drive
8	Encoder Connect Error	Cable connection error with Encoder connection in drive
10	In-Position Error	After operation is finished, a position error occurs
12	ROM Error	Error occurs during tuning execution
15	Position Overflow Error	Position error value is higher than 90° in motor stop state *1

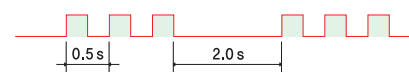

Alarm LED or 7-Segment flash
(Ex, Position tracking error)

*1 : Default value can be changed by parameter (Refer to the Manual)

1. Network ID Selection Switch(SW2)

Position	ID Number	Position	ID Number
0	0	8	8
1	1	9	9
2	2	A	10
3	3	B	11
4	4	C	12
5	5	D	13
6	6	E	14
7	7	F	15



- ※ Maximum 16 axis can be connected in one network,
- ※ Ezi-SERVO-ALL-60 series only,
- ※ The network ID of Ezi-SERVO-ALL-60-ABS can be set under RS-485 communication

2. Speed and Termination Setting Switch

◆ Ezi-SERVO-ALL-60 series

Termination Setting Switch(SW1.4)

The drive installed at the end of the network must be terminated for reliable operation. Please termination setting switch is On if drive installed at the end of the network,

Speed Setting Switch(SW1.1~SW1.3)

SW1.1~ SW1.3 used for setting speed as follows

SW1.1	SW1.2	SW1.3	SW1.4	Baud Rate [bps]
OFF	OFF	OFF	-	9,600
ON	OFF	OFF	-	19,200
OFF	ON	OFF	-	38,400
ON	ON	OFF	-	57,600
OFF	OFF	ON	-	115,200*1
ON	OFF	ON	-	230,400
OFF	ON	ON	-	460,800
ON	ON	ON	-	921,600

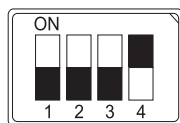

Ezi-SERVO-ALL-60 series
Speed and Termination Setting Switch (SW1)

Termination setting switch
Speed setting switch

*1 : Default setting value

◆ Ezi-SERVO-ALL-60-ABS series

Termination Setting Switch(SW1)

The drive installed at the end of the network must be terminated for reliable operation. Please termination setting switch is On if drive installed at the end of the network,



Ezi-SERVO-ALL-60-ABS series
Termination Setting Switch (SW1)

3. Power Connector(CN3)

NO.	Function	I/O
1	24VDC	Input
2	24VDC	Input
3	GND	Input
4	GND	Input

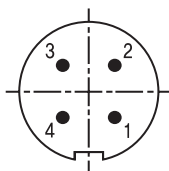

4. Input/Output Signal Connector(CN1)

◆ Ezi-SERVO-ALL-60 series

NO.	Function	I/O
A	EXT_24VDC	Input
B	EXT_GND	Input
C	LIMIT+	Input
D	LIMIT-	Input
E	ORIGIN	Input
F	Digital In1	Input
G	Digital In2	Input
H	Digital In3	Input
I	Digital In4	Input
K	Digital In5	Input
L	Digital In6	Input
M	Digital In7	Input
N	Compare Out	Output
O	Digital Out1	Output
P	Digital Out2	Output
R	Digital Out3	Output
S	NC	----
T	BRAKE+	Output
U	BRAKE-	Output

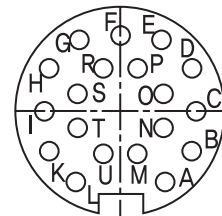

◆ Ezi-SERVO-ALL-60-ABS series

NO.	Function	I/O
A	EXT_24VDC	Input
B	EXT_GND	Input
C	LIMIT+	Input
D	LIMIT-	Input
E	ORIGIN	Input
F	Digital In1	Input
G	Digital In2	Input
H	Digital In3	Input
I	Digital In4	Input
K	Digital In5	Input
L	Digital In6	Input
M	Digital Out1	Output
N	Digital Out2	Output
O	Digital Out3	Output
P	Digital Out4	Output
R	Digital Out5	Output
S	Digital Out6	Output
T	BRAKE+	Output
U	BRAKE-	Output

5. RS-485 Communication Connector(CN5, CN6)

NO.	Function
1	Data+
2	Data-
3	GND

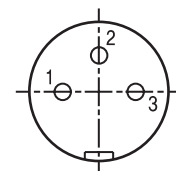

● System Configuration [Ezi-SERVO-ALL-60/60-ABS series]

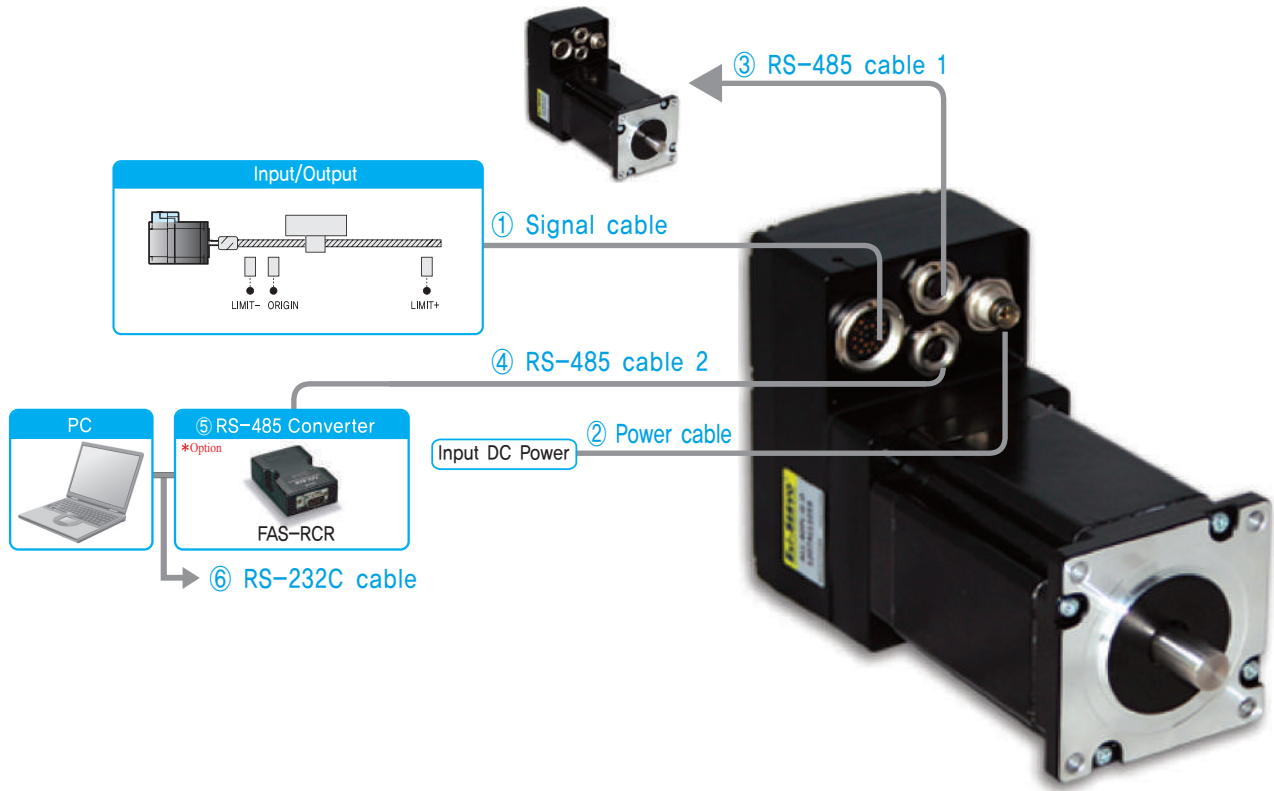

Type	Signal Cable	Power Cable	RS-485 Cable
Length supplied	-	-	-
Max. Length	20m	2m	30m

1. Options

① Signal Cable

Available to connect between Input/Output signals and Ezi-SERVO-ALL-60/60-ABS.

Item	Length [m]	Remark
CWPA-S-□□□F ^{*1}	□□□	Normal Cable
CWPA-S-□□□M ^{*1}	□□□	Robot Cable
CAPA-S-□□□F ^{*2}	□□□	Normal Cable
CAPA-S-□□□M ^{*2}	□□□	Robot Cable

^{*1} Ezi-SERVO-ALL-60 series

^{*2} Ezi-SERVO-ALL-60L-ABS series

□ is for Cable Length, The unit is 1m and Max. 20m length.

② Power Cable

Available to connect between Power and Ezi-SERVO-ALL-60/60-ABS.

Item	Length [m]	Remark
CWPA-P-□□□F	□□□	Normal Cable
CWPA-P-□□□M	□□□	Robot Cable

□ is for Cable Length, The unit is 1m and Max. 2m length.

③ RS-485 Cable 1

Item	Length [m]	Remark
CWPA-R-0R6F	0,6	Normal Cable
CWPA-R-001F	1	
CWPA-R-1R5F	1,5	
CWPA-R-002F	2	
CWPA-R-003F	3	
CWPA-R-005F	5	

Item	Length [m]	Remark
CWPA-R-0R6M	0,6	Robot Cable
CWPA-R-001M	1	
CWPA-R-1R5M	1,5	
CWPA-R-002M	2	
CWPA-R-003M	3	
CWPA-R-005M	5	

* Cable to connect Ezi-SERVO-ALL-60/60-ABS series by Network.

④ RS-485 Cable 2

FAS-RCR to Ezi-SERVO-ALL-60/60-ABS series drive.

Item	Length [m]	Remark
CWPB-R-0R6F	0,6	Normal Cable
CWPB-R-001F	1	
CWPB-R-1R5F	1,5	
CWPB-R-002F	2	
CWPB-R-003F	3	
CWPB-R-005F	5	

⑤ FAS-RCR(RS-232C to RS-485 Converter)

Item	Specification
Comm. Speed	Max, 115,2 [kbps]
Comm. Distance	RS-232C: Max, 15m RS-485: Max, 1,2km
Connection Type	RS-232C: DB9 Female RS-485: RJ-45
Dimension	50×75×23mm
Weight	38g
Power	Powered from PC (Usable for external DC5~24V)

⑥ RS-232C Cable

Item	Length [m]	Remark
CGNR-C-002F	2	Normal Cable
CGNR-C-003F	3	
CGNR-C-005F	5	

2. Connector Specifications

Connector specifications for cabling to drive.

Purpose	Item	Part Number	Manufacturer
Power (CN2)	Connector	99-0410-00-04	BINDER
Signal (CN1)	Connector	99-5461-40-19	BINDER
RS-485 Communication (CN3, CN4)	Connector	99-0405-00-03	BINDER

※ Above connector is the most suitable product for the drive applied. Another equivalent connector can be used.

External Wiring Diagram [Ezi-SERVO-ALL-60 series]

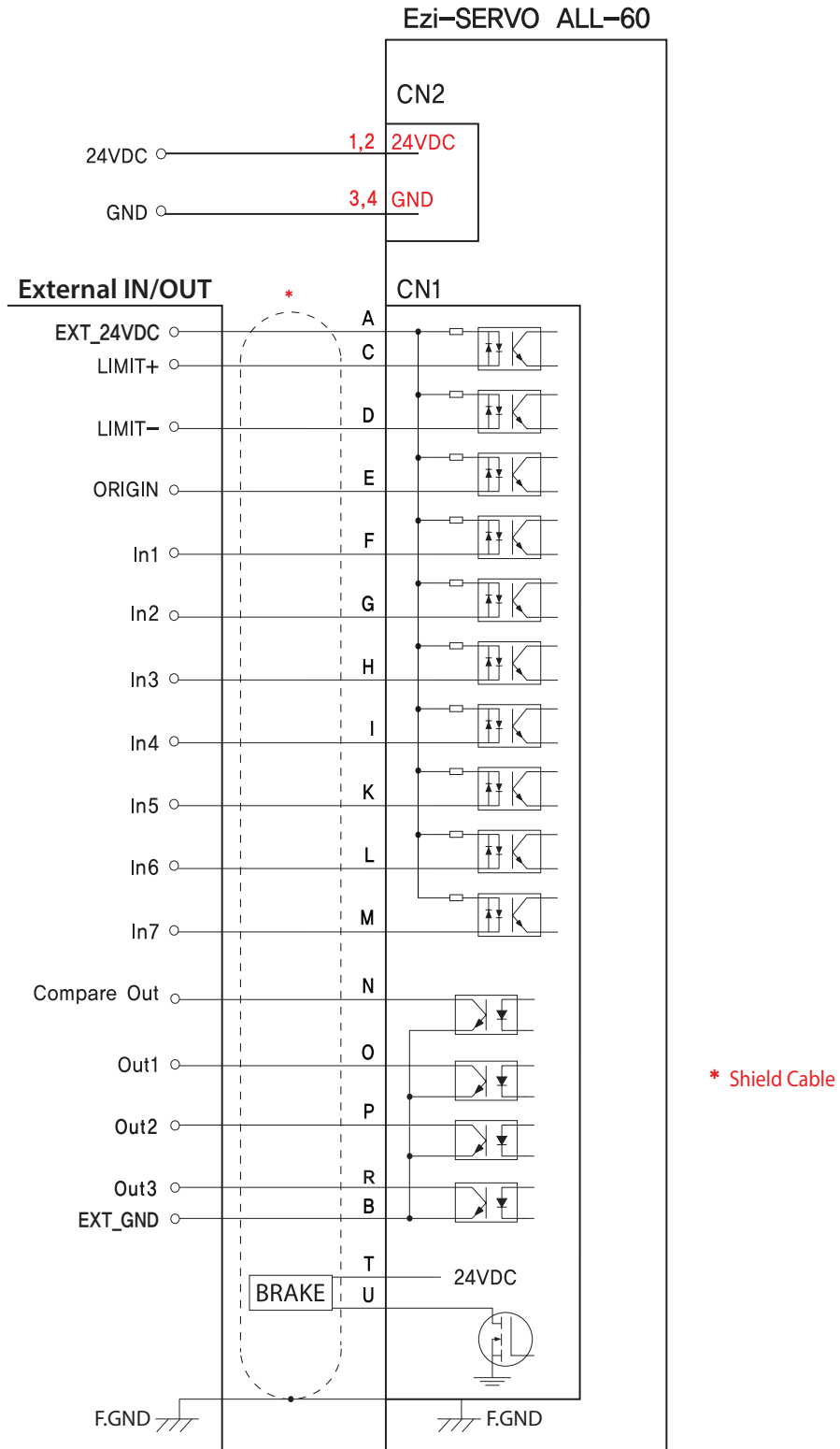

※ When connects I/O cable between controller and drive, please turn off the power of both controller and drive, in order to protect the drive from any damage.

● External Wiring Diagram [Ezi-SERVO-ALL-60-ABS series]

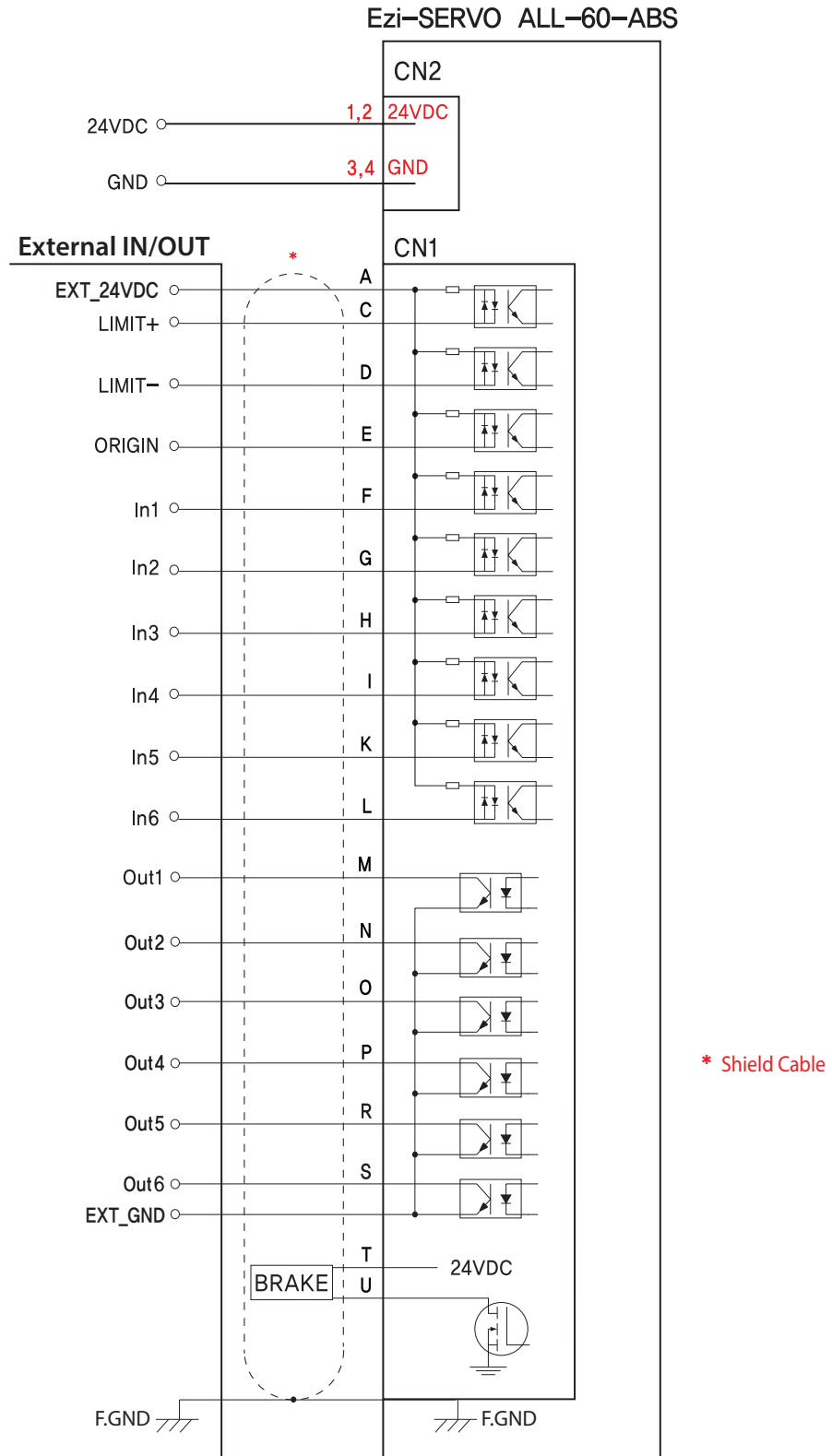

※ When connects I/O cable between controller and drive, please turn off the power of both controller and drive, in order to protect the drive from any damage.

● GUI(Graphic User Interface) Screenshot



◆ Controller Lists and Motion Test

This screen display the controller list that connected to system, You can make a single move, jog and origin command and also the motor status is displayed.

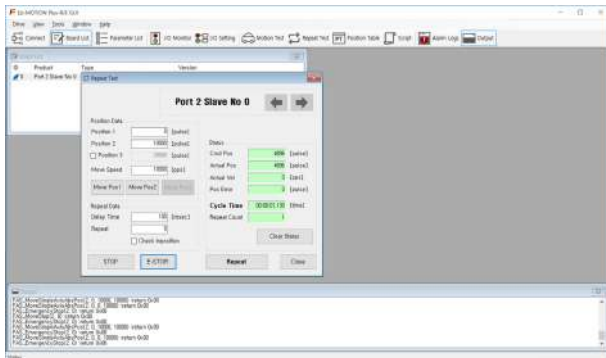

◆ Motion Repeat and Monitor Status

Target position, speed, delay time and repeat count are selected for repeat motion test. Motion library(DLL) is also displayed on screen.

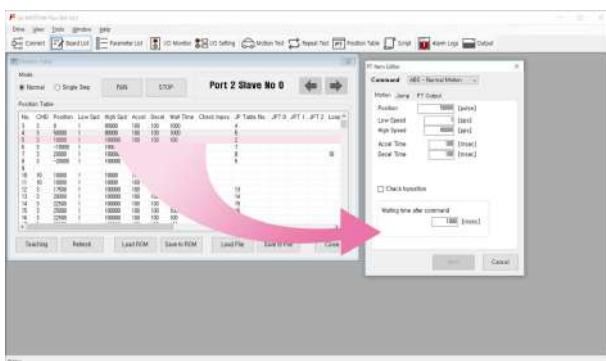

◆ Position Table

You can edit the position table and execute it, The position table data can be saved and loaded from Flash ROM and Windows file.

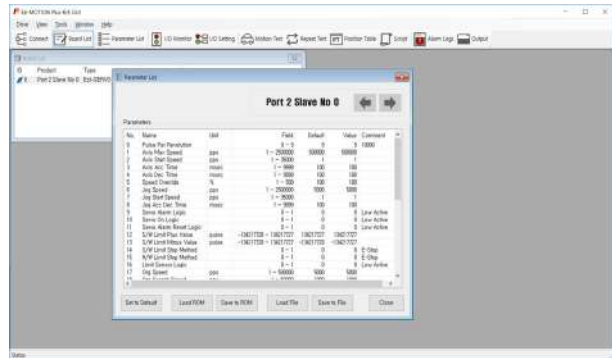

◆ Parameter List

All of the parameters are displayed and modified on this screen.

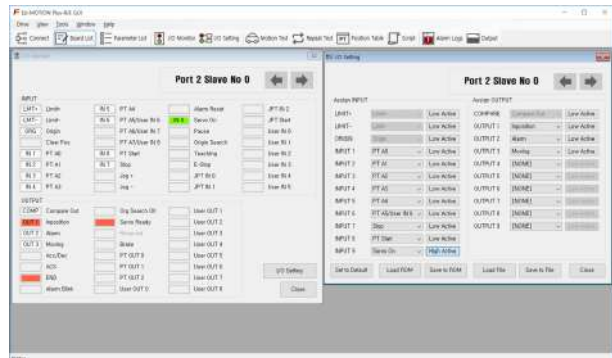

◆ I/O Monitoring and Setting

You can select various digital input and output signals of controller.



- ※ Graphic User Interface(GUI) Program can be downloaded from website, (www.fastech.co.kr)
- ※ Graphic User Interface(GUI) Program can support Window XP/7/8/10,
- ※ Graphic User Interface(GUI) Program can be update without prior notice for improving the performance or convenience of user.

MEMO

FASTECH Ezi-SERVO ALL

MEMO



Fast, Accurate, Smooth Motion

FASTECH Co., Ltd.

Rm#1202, 401-dong, Bucheon Techno-Park,
655, Pyeongcheon-ro, Bucheon-si Gyeonggi-do,
Republic of Korea (Zip:14502)
TEL : +82-32-234-6300 FAX : +82-32-234-6302
E-mail : fastech@fastech.co.kr
Homepage : www.fastech.co.kr